

FREEMAN

PROJECT Cyber Security Pavilion
BOOTH #

SHOW NAME HIMSS 2020
SHOW DATE 3/10/2020 through 3/12/2020
SHOW LOCATION Orange Cty Conv Center, FL

SALES CONTACT Sarah Johnson
JOB NUMBER 454446
LINE ITEM NUMBER 5205851

CREATED BY K Krayer | O Romero CREATION DATE 8/1/2019
REVISED 8/1/2019
PRODUCING BRANCH Orlando

FILE NAME P:/Chicago/Branch/NCRDC/_Out of Region/2020/HIMSS (454446)/Expo/Cybersecurity Pavilion/CAD/HIMSS20 Cyber Security Pavilion 5205851 DES.dwg

The text, graphics, designs, logos, data compilations and information ("Content") contained in this Proposal are owned or controlled by Freeman and are protected by United States and international copyright and trade secret laws. Modification or reproduction of the Content for any purpose is strictly prohibited.

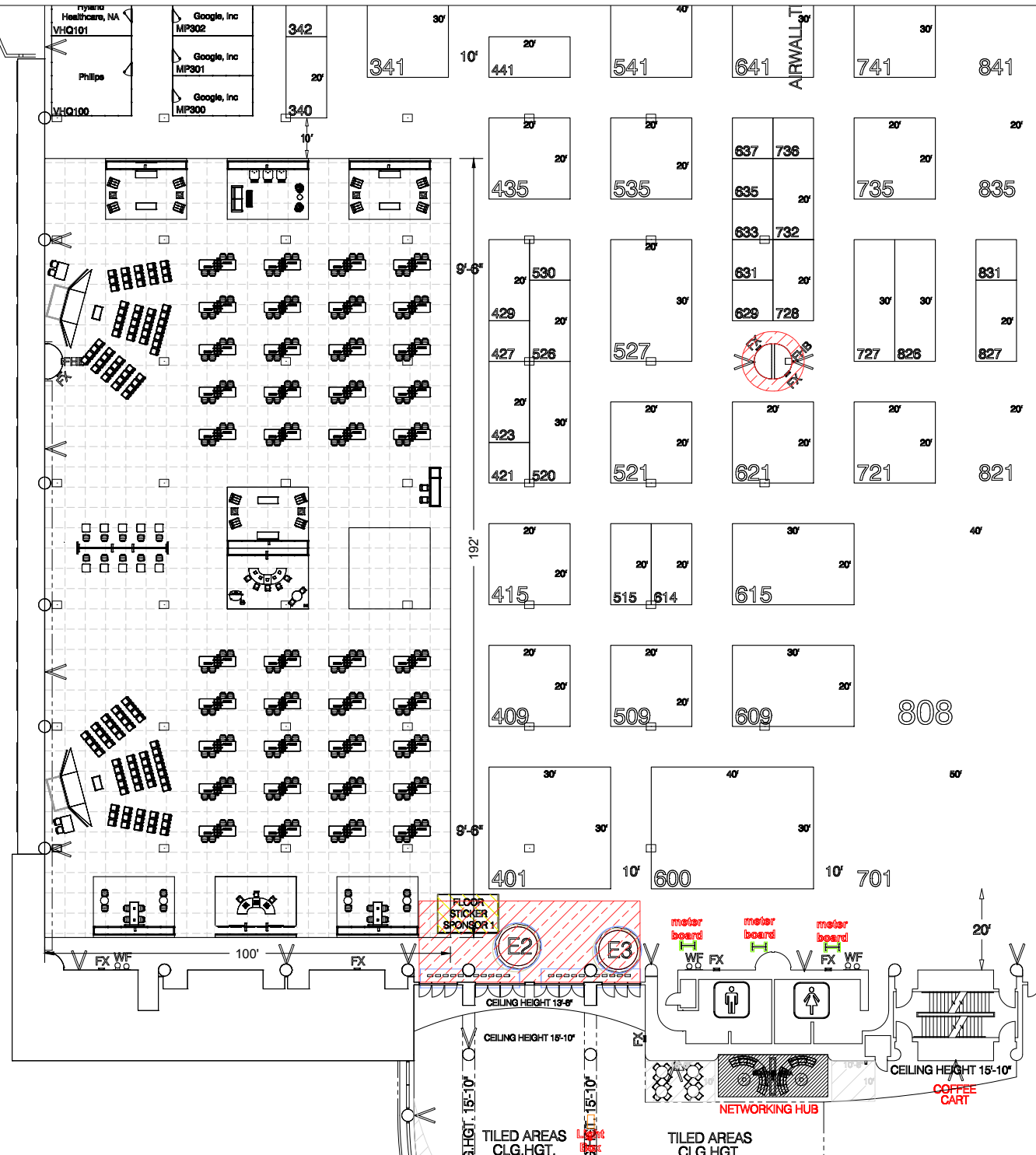

PLAN

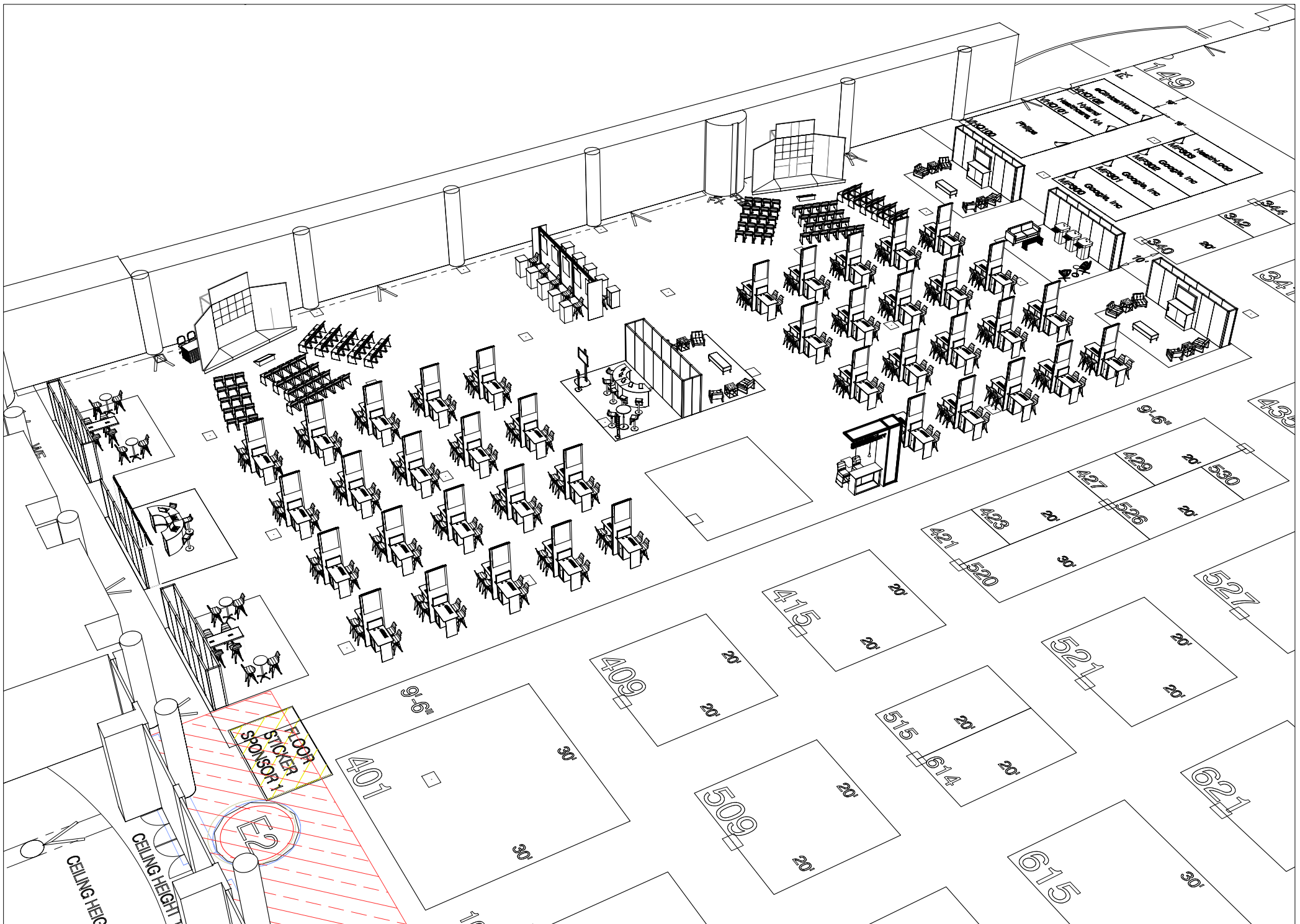

FREEMAN

PROJECT Cyber Security Pavilion
BOOTH #

SHOW NAME HIMSS 2020
SHOW DATE 3/10/2020 through 3/12/2020
SHOW LOCATION Orange Cty Conv Center, FL

SALES CONTACT Sarah Johnson
JOB NUMBER 454446
LINE ITEM NUMBER 5205851

CREATED BY K Krayter | O Romero CREATION DATE 8/1/2019
REVISED 8/1/2019
PRODUCING BRANCH Orlando

FILE NAME P:/Chicago/Branch/NCRDC/_Out of Region/2020/HIMSS (454446)/Expo/Cybersecurity Pavilion/CAD/HIMSS20 Cyber Security Pavilion 5205851 DES.dwg

The text, graphics, designs, logos, data compilations and information ("Content") contained in this Proposal are owned or controlled by Freeman and are protected by United States and international copyright and trade secret laws. Modification or reproduction of the Content for any purpose is strictly prohibited.

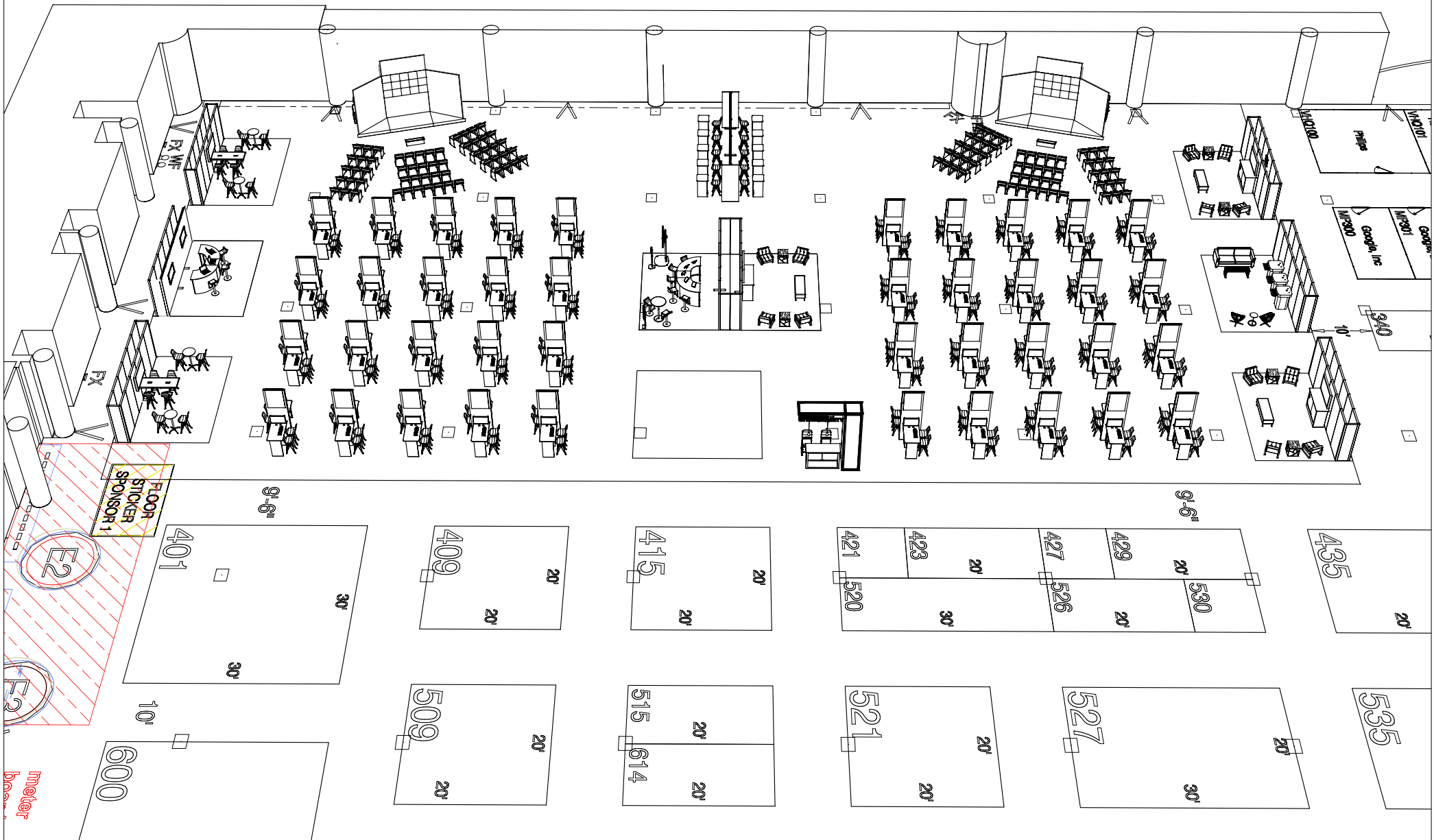

FREEMAN

PROJECT Cyber Security Pavilion
BOOTH #

SHOW NAME HIMSS 2020
SHOW DATE 3/10/2020 through 3/12/2020
SHOW LOCATION Orange Cty Conv Center, FL

SALES CONTACT Sarah Johnson
JOB NUMBER 454446
LINE ITEM NUMBER 5205851

CREATED BY K Krayer | O Romero CREATION DATE 8/1/2019
REVISED 8/1/2019
PRODUCING BRANCH Orlando

FILE NAME P:/Chicago/Branch/NCRDC/_Out of Region/2020/HIMSS (454446)/Expo/Cybersecurity Pavilion/CAD/HIMSS20 Cyber Security Pavilion 5205851 DES.dwg

The text, graphics, designs, logos, data compilations and information ("Content") contained in this Proposal are owned or controlled by Freeman and are protected by United States and international copyright and trade secret laws. Modification or reproduction of the Content for any purpose is strictly prohibited.

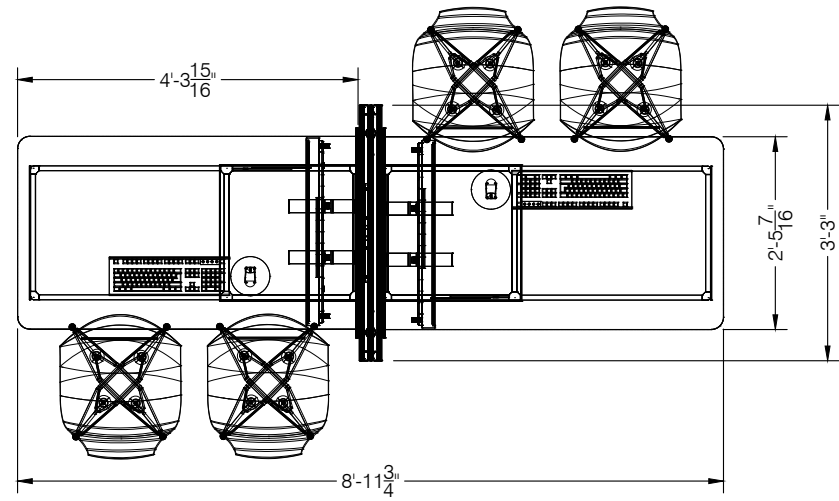
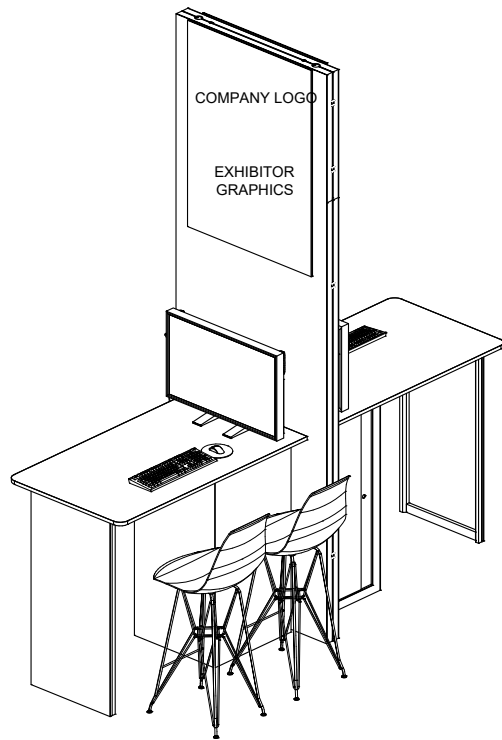

KIOSK									
I.D.	Qty	Type	Size	Area (SqFt)	Part Number	Description	Material	Color	Notes
1	1	Assembly	See detail			BACK WALL	See detail	See detail	
2	2	Assembly	See detail			CABINET	See detail	See detail	
2	2	Electronics	28-7/8" x 2" x 16-7/8"			32" LCD Monitor w/ Table Stand	Standard	Black	
4	4	Seating	19" x 20" x 44"H			Zenith Barstool, White, Chrome	Plastic	White	

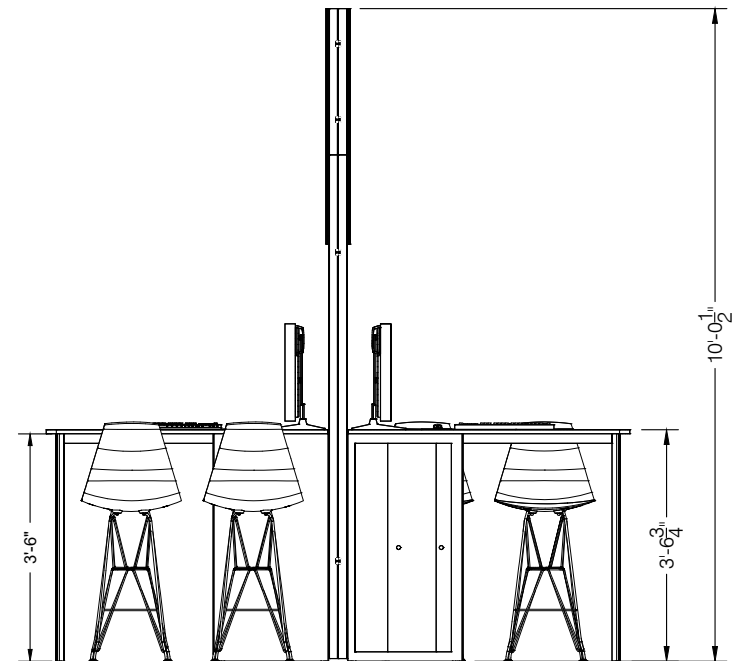

UNIT TO BE ORDERED ON SEPARATE LINE ITEM

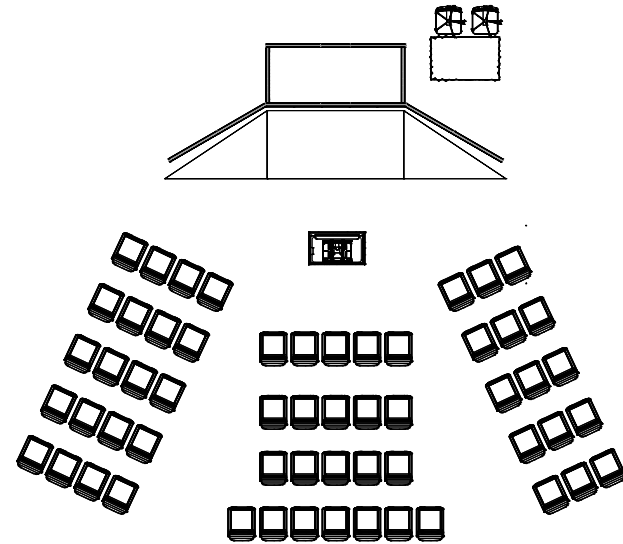
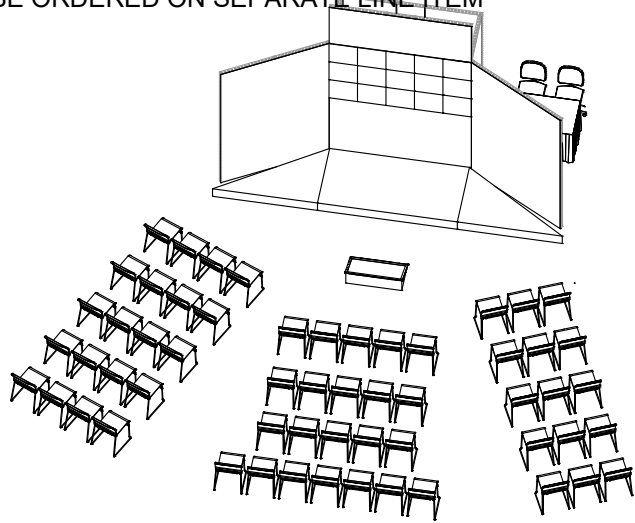

THEATER							
I.D.	Qty	Type	Size	Area (SqFt)	Part Number	Description	Material Color Notes
	1	Electronics	39-1/2" x 1-3/4" x 24-3/4"			42" LCD Monitor w/ Wall Bracket	Standard Black
	1	Drape Tables	72" x 30" x 30"			6x30x30 Drape Table	Standard Standard
	3	FLEX Frame-Straight	19-1/2" x 39-1/16"	0		Straight Frame 08 Hole x 16 Hole	Aluminum Silver SF08160001
	1	FLEX Frame-Straight	19-1/2" x 58-9/16"	0		Straight Frame 08 Hole x 24 Hole	Aluminum Silver SF08240001
	1	FLEX Frame-Straight	19-1/2" x 117-3/16"	0		Straight Frame 08 Hole x 48 Hole	Aluminum Silver SF08480001
	4	FLEX Frame-Straight	39-1/16" x 39-1/16"	0		Straight Frame 16 Hole x 16 Hole	Aluminum Silver SF16160001
	8	FLEX Frame-Straight	39-1/16" x 117-3/16"	0		Straight Frame 16 Hole x 48 Hole	Aluminum Silver SF16480001
	2	Flex Graphic Fabric	78-1/8" x 117-3/16"	63.55		Flex Graphic Fabric [1984X2976MM]	Fabric Graphic
	1	Flex Graphic Fabric	93-5/8" x 58-9/16"	39.72		Flex Graphic Fabric [2480X1480MM]	Fabric Graphic
	1	Flex Graphic Fabric	93-5/8" x 39-1/16"	26.48		Flex Graphic Fabric [2480X992MM]	Fabric Graphic
	1	Flex Insert	19-1/4" x 58-5/16"	7.8		Flex Insert [496X1480MM]	PVC 3MM White
	2	Flex Insert	19-1/4" x 116-7/8"	15.63		Flex Insert [496X2976MM]	PVC 3MM White
	3	Flex Insert	19-1/4" x 38-3/4"	5.18		Flex Insert [496X992MM]	PVC 3MM White
	12	Flex Insert	38-3/4" x 116-7/8"	31.48		Flex Insert [992X2976MM]	PVC 3MM White
	4	Flex Insert	38-3/4" x 38-3/4"	10.44		Flex Insert [992X992MM]	PVC 3MM White
	4	Seating	27" x 26" x 30"			Fairfax Chair, White Vinyl/ Brushed Metal	Vinyl White
	3	Seating	62" x 26" x 30"			Fairfax Sofa, White Vinyl/Brushed Metal	Vinyl White
	2	Seating	26" x 20" x 38"			Gray Gaslift Chair - without Arms	Fabric Gray
	37	Seating	18" x 17.75" x 33"			Limerick Chair	Plastic Gray
	3	Tables	48" x 26" x 18"			Sydney Cocktail Table, White	Laminate White

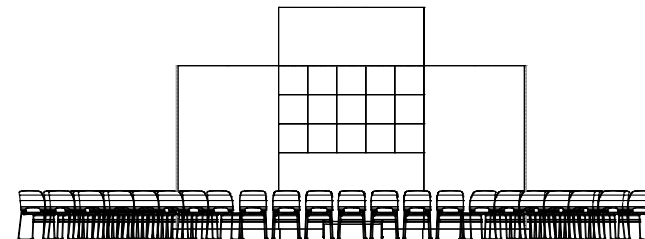

UNIT TO BE ORDERED ON SEPARATE LINE ITEM

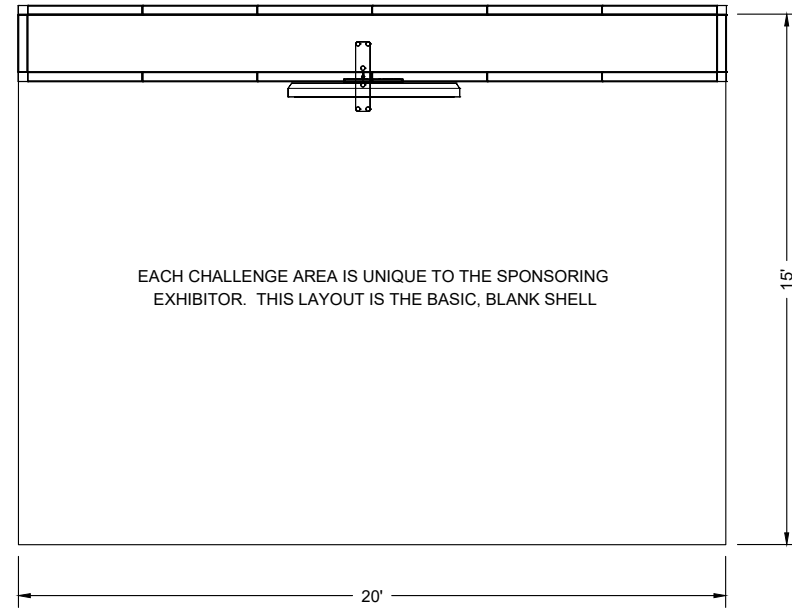
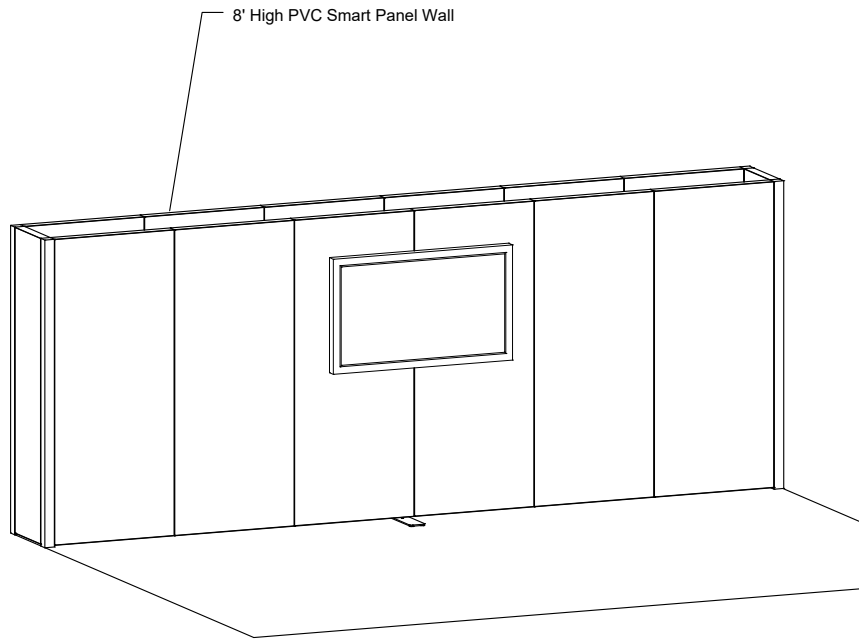

CHALLENGE AREA

I.D.	Qty	Type	Size	Area (SqFt)	Part Number	Description	Material	Color	Notes
	1	Electronics	61"			61"-Plasma Screen	Standard	Standard	
	2	PV80	3-5/32" x 3-5/32" x 93-1/2"			93-1/2"	Aluminum	Silver	
	1	SP Foot	23-5/8" x 4-15/16"	0		24" Foot	Aluminum	Silver	
	6	SP Frame	39" x 93"			8' Full SmartPanel Frame	Aluminum	Silver	
	2	SP Frame	19-1/2" x 93"			8' Half SmartPanel Frame	Aluminum	Silver	
	4	SP Panel	19-1/8" x 92-5/8"	12.30		Panel From Edge to Edge	PVC	White	
	12	SP Panel	38-5/8" x 92-5/8"	24.84		Panel From Edge to Edge	PVC	White	

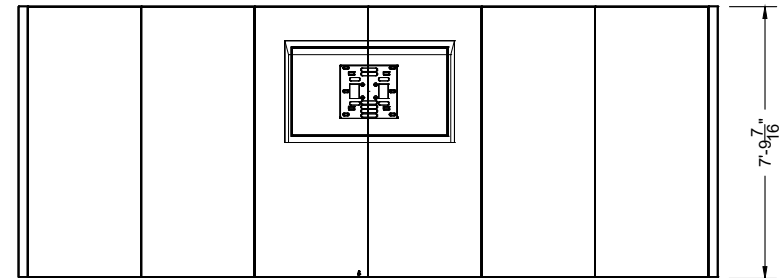

UNIT TO BE ORDERED ON SEPARATE LINE ITEM

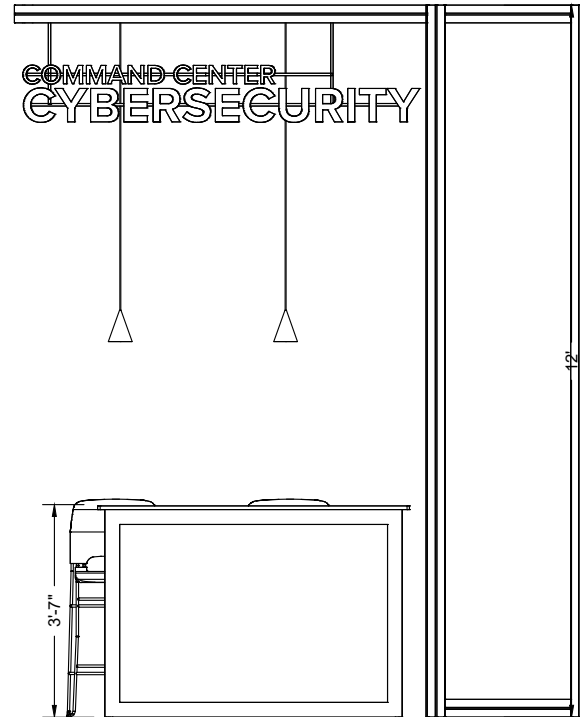
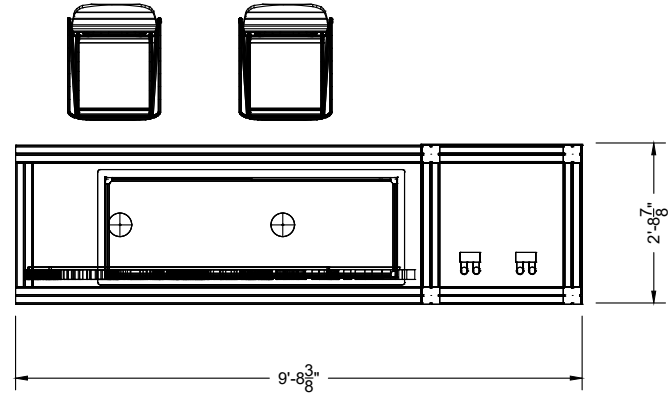
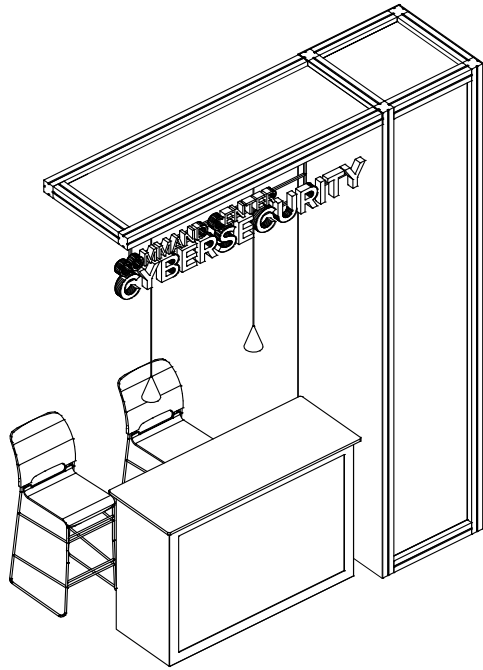

RECEPTION COUNTER

I.D.	Qty	Type	Size	Area (SqFt)	Part Number	Description	Material	Color	Notes
	4	P31	42"			3'-6" (42")	Aluminum	Silver	
	4	PS3.5 (Vert.)	144"			12'-0"	Aluminum	Silver	
	1	PS3.5 (Hor.)	1/4"			1/4"	Aluminum	Silver	
	9	PS3.5 (Hor.)	25-7/16"			3/4M	Aluminum	Silver	
	2	PS3.5 (Hor.)	83-9/16"			2-1/4M	Aluminum	Silver	
	4	H45	17-7/8"			1/2M	Aluminum	Silver	
	4	H45	57-1/4"			1-1/2M	Aluminum	Silver	
	2	Wall Panel	18-3/8" x 39"	5.0		1/2M x 3'-6" (H45/H45)	PVC 3MM	White	
	4	Wall Panel	25-15/16" x 137-1/4"	24.7		3/4M x 12'-0" (PS3.5 H/PS3.5 H)	PVC 3MM	White	
	1	Acrylic Panel	57-3/4" x 39"	15.6		1-1/2M x 3'-6" (H45/H45)	Plex 1/8	Backlit White	
	1	Overlay Panel	20-9/16" x 42"	6.00		P31 CS/1/2M/P31 CS, Remo Tape 1/16"	PVC 3MM	White	
	1	Overlay Panel	20-11/16" x 42"	6.03		P31 CL/1/2M/P31 CS, Remo Tape 1/16"	PVC 3MM	White	
	1	Overlay Panel	60-3/16" x 42"	17.55		P31 CL/1-1/2M/P31 CL, Remo Tape 1/16"	PVC 3MM	White	
	2	Std. Cab. Door	29-1/2" x 38-1/4"	7.9		1-1/2M x 42" (H45/H45)	PVC 6MM	White	
	1	Counter Top	1-1/2M x 1/2M	10.37		Overlay Rectangle	Wood	White	
	2	Door Track	57-1/4"			HDT 1-1/2M	Standard	Standard	
	2	Door Track	37-1/2"			VDI 42" (H45/H45)	Standard	Standard	
	2	Lighting	96"			Face Mount Fluorescent-8'-0"	Standard	Standard	
	2	Select Furniture	16.75" x 16" x 37.75"		810815	ICE Barstool	Standard	Transparent, Chrome	

UNIT TO BE ORDERED ON SEPARATE LINE ITEM

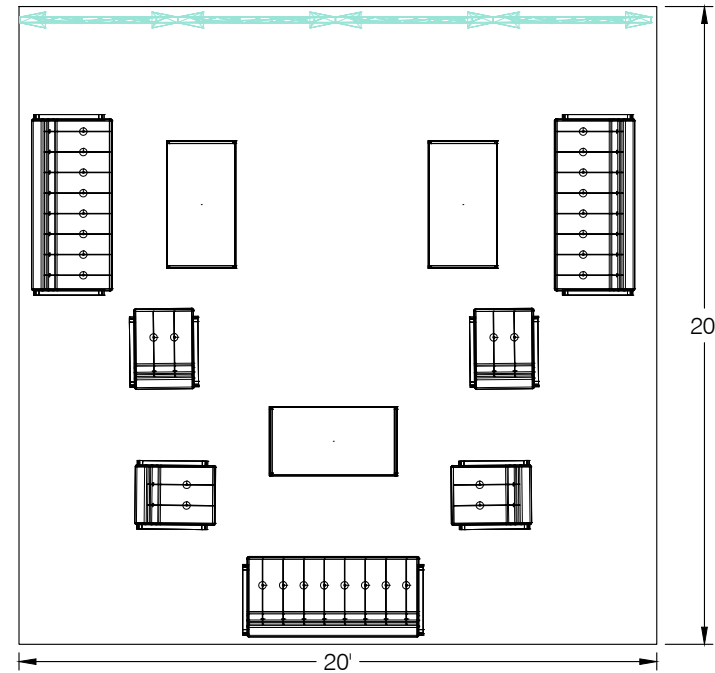
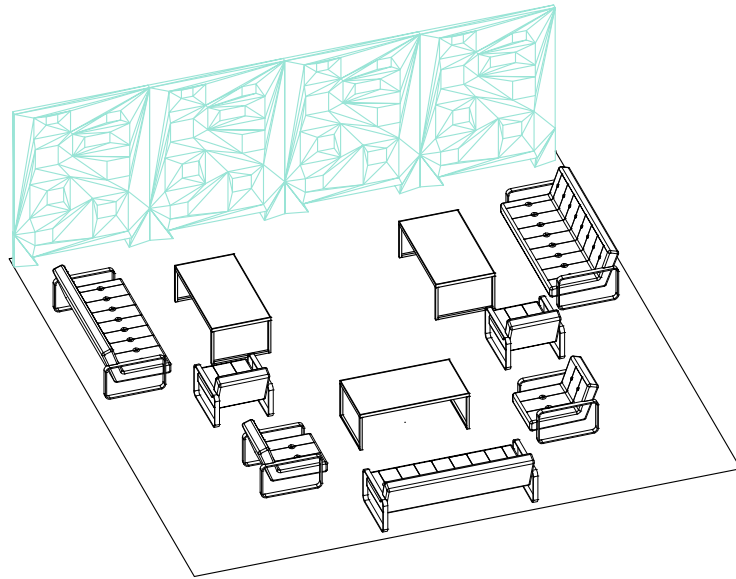

CYBERLOUNGE										
ID.	Qty	Type	Size	Area (SqFt)	Part Number	Description	Material	Color	Notes	
	2	PS35 (Vert.)	24"			2'-0"	Aluminum	Silver		
	4	PS35 (Vert.)	96"			8'-0"	Aluminum	Silver		
	4	PS35 (Vert.)	120"			10'-0"	Aluminum	Silver		
	4	PS35 (Hor.)	25-7/16"			3/4M	Aluminum	Silver		
	8	PS35 (Hor.)	35-1/8"			1M	Aluminum	Silver		
	2	PS35 (Hor.)	83-9/16"			2-1/4M	Aluminum	Silver		
	2	PS35 (Hor.)	151-3/8"			4M	Aluminum	Silver		
	2	Wall Panel	25-15/16" x 89-1/4"	16.1		3/4M x 8'-0" (PS35 H/PS35 H)	PVC 3MM	White		
	2	Wall Panel	35-5/8" x 89-1/4"	22.1		1M x 8'-0" (PS35 H/PS35 H)	PVC 3MM	White		
	2	Wall Panel	35-5/8" x 113-1/4"	28.0		1M x 10'-0" (PS35 H/PS35 H)	PVC 3MM	White		
	3	Overlay Panel	38-13/16" x 96"	25.88		PS35 CL/1M/PS35 L, Remo Tape 1/16"	PVC 3MM	White		
	1	Overlay Panel	42-9/16" x 96"	28.38		PS35 CL/1M/PS35 CS, Remo Tape 1/16"	PVC 3MM	White		
	4	PV80	3-5/32" x 3-5/32" x 93-1/2"			93-1/2"	Aluminum	Silver		
	2	SP Foot	23-5/8" x 4-15/16"	0		24" Foot	Aluminum	Silver		
	12	SP Frame	39" x 93"			8" Full SmartPanel Frame	Aluminum	Silver		
	2	SP Frame	19-1/2" x 93"			8" Half SmartPanel Frame	Aluminum	Silver		
	4	SP Panel	19-1/8" x 92-5/8"	12.30		Panel From Edge to Edge	PVC	White		
	24	SP Panel	38-5/8" x 92-5/8"	24.84		Panel From Edge to Edge	PVC	White		
	4	Seating	27" x 26" x 30"			Fairfax Chair, White Vinyl/ Brushed Metal	Vinyl	White		
	3	Seating	62" x 26" x 30"			Fairfax Sofa, White Vinyl/Brushed Metal	Vinyl	White		
	3	Tables	48" x 26" x 18"			Sydney Cocktail Table, White	Laminate	White		

