

Freeman¹

Column Wrap 18

Marriott RCL3 Prefunction

AAAAI 2023 Annual Conference

Jul 15, 2022





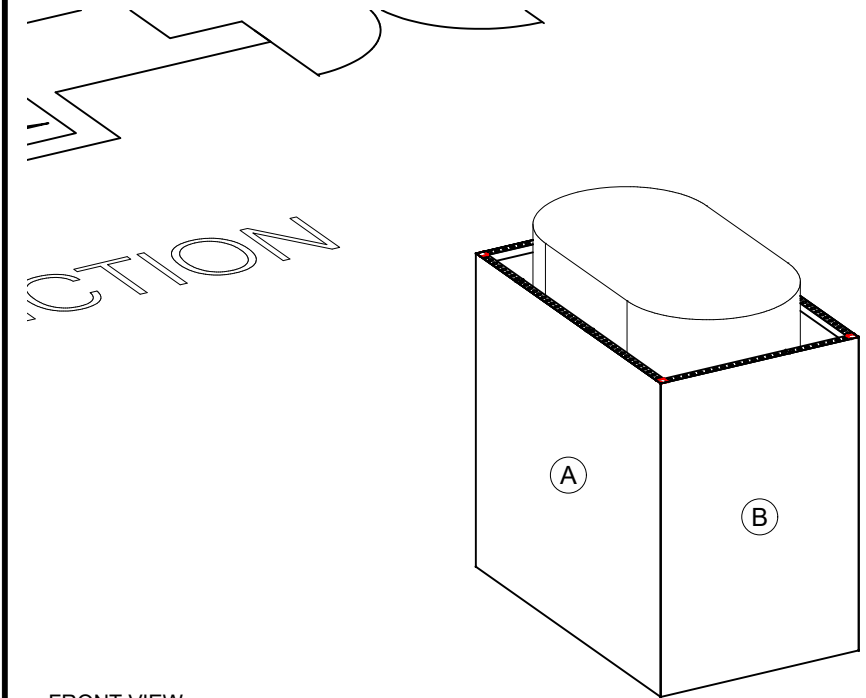

FRONT VIEW

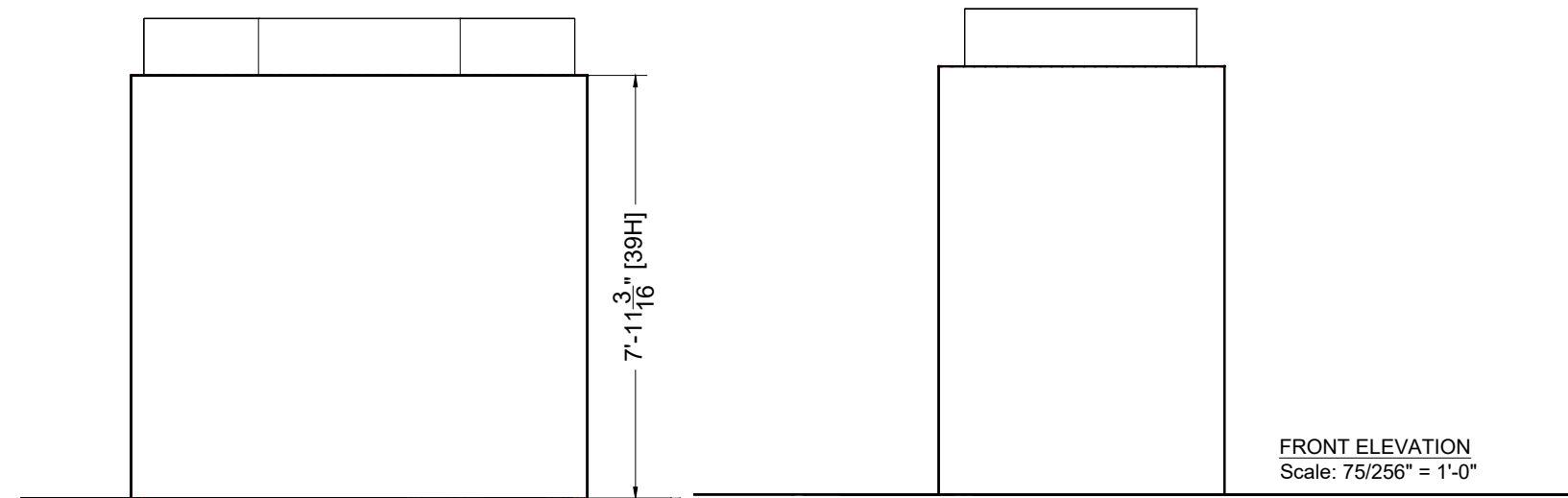

SIDE ELEVATION
Scale: 37/128" = 1'-0"

FRONT ELEVATION
Scale: 75/256" = 1'-0"

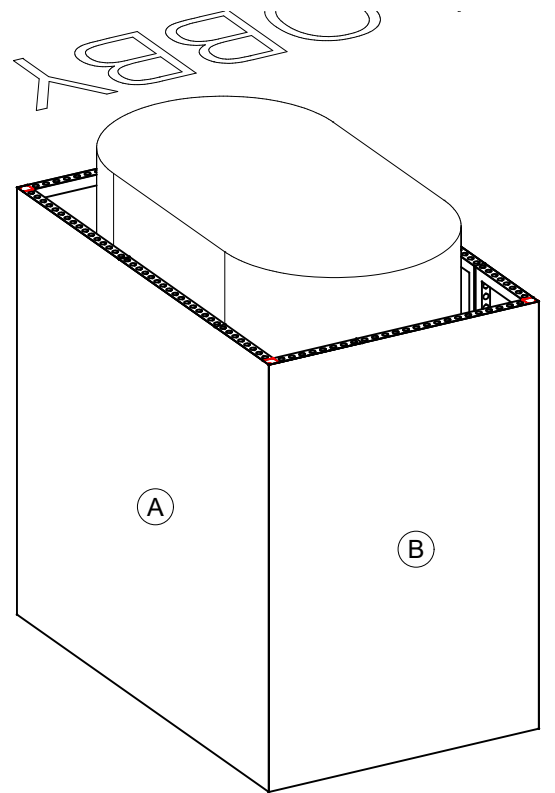

BACK VIEW

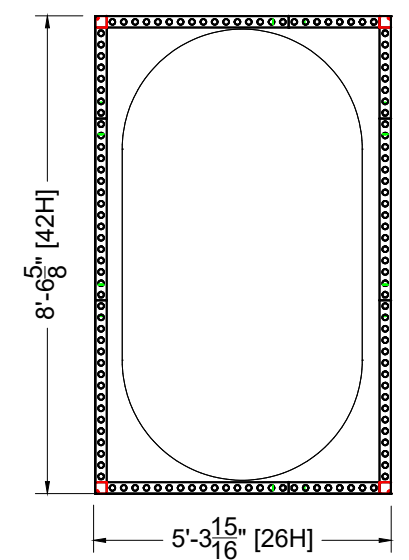

PLAN VIEW
Scale: 37/128" = 1'-0"

Not for Production

I.D.	Qty	Type	Size	Area (SqFt)	Part Number	Description	Material	Color	Low Inv.
	4	FLEX Frame-Straight	19-1/2" x 95-3/16"		60400028	Straight Frame 08 Hole x 39 Hole	Aluminum	Silver	
	6	FLEX Frame-Straight	39-1/16" x 95-3/16"		60400043	Straight Frame 16 Hole x 39 Hole	Aluminum	Silver	
	8	FLEX Acc-Corner Post	0-5/16"		604440019	End piece for fabrics	Steel	Gray	X
	4	FLEX Acc-Corner Post	94-9/16"		604440020	Cnr prof for fabric w/ 4 sides + thrds [2402MM]	Steel	Gray	
C1	12	FLEX Part-Connector	Standard		604440043	Manual Clamp Connector	Aluminum	Silver	
A	2	FLEX Fabric Graphic	102-1/2" x 95-3/16"	67.8		102-1/2" x 95-3/16" FLEX Fabric Graphic	Fabric	Graphic	
B	2	FLEX Fabric Graphic	63-7/16" x 95-3/16"	41.9		63-7/16" x 95-3/16" FLEX Fabric Graphic	Fabric	Graphic	