

Interop Showcase
 AIRWALL TRACK CEILING HEIGHT: 28'-10"

TANGERINE BALLROOM
 W HALL F CEILING HEIGHT:
 30' TO BEAM

Bio-Engineering

Blockchain

Innovation Live
 AIRWALL TRACK CEILING HEIGHT: 28'-10"

AI/Voice

PLAN - 5' GRID

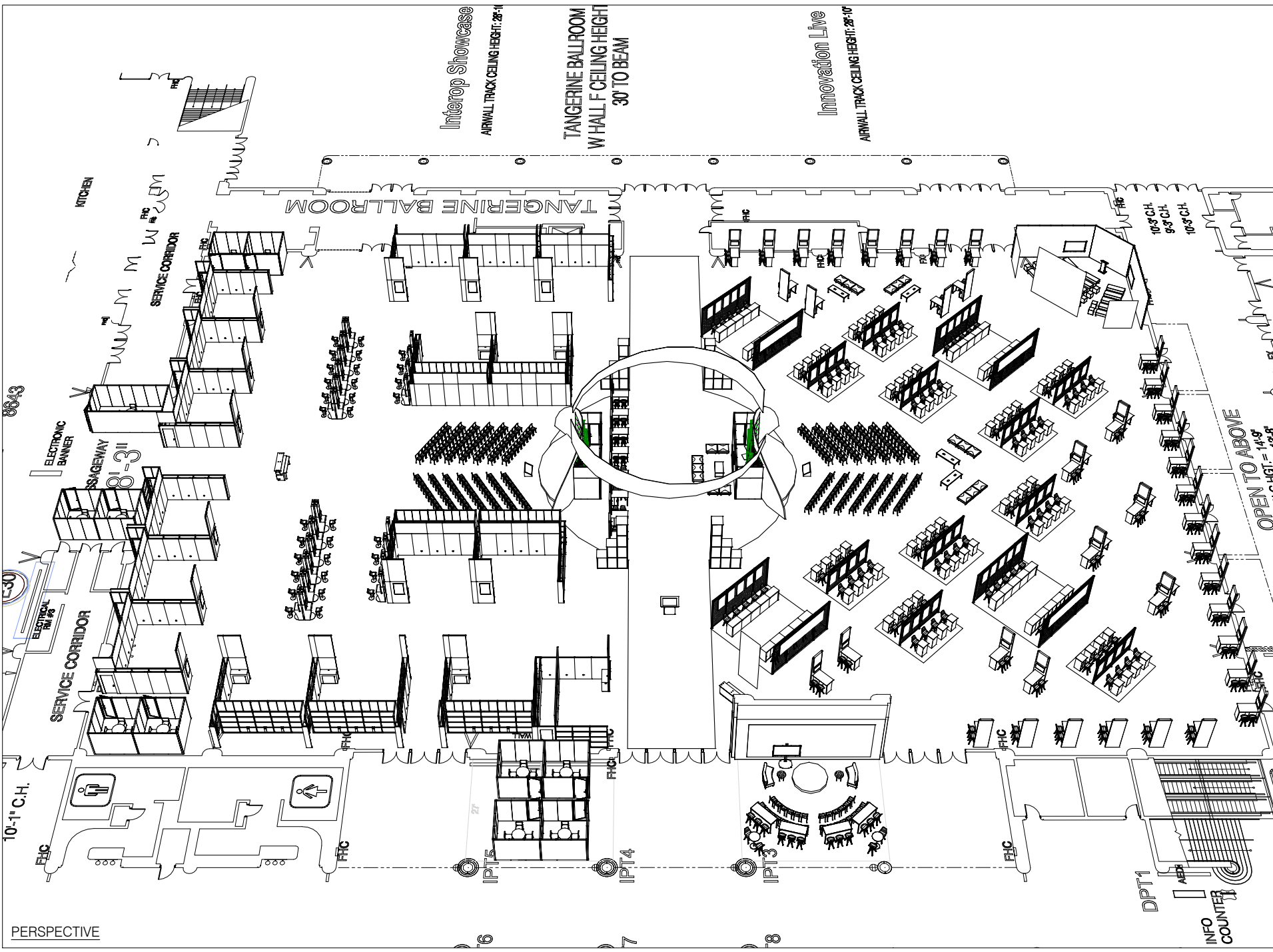

PERSPECTIVE

FREEMAN

PROJECT Innovation Live
BOOTH # 9001

SHOW NAME HIMSS 2019
SHOW DATE 2/12/2019 through 2/14/2019
SHOW LOCATION OCCDC, FL

SALES CONTACT Moriah Hathway-Casey
JOB NUMBER 452520
LINE ITEM NUMBER 4689671

CREATED BY Orlando Romero

CREATION DATE 8/27/2018
REVISED 8/27/2018

PRODUCING BRANCH Orlando

FILE NAME P: /Chicago/Branch/NCRDC/_Out of Region/2019/HIMSS(452520)/Expo/Innovation Live/CAD/HIMSS19 Innovation Live 4689671 DES.dwg

The text, graphics, designs, logos, data compilations and information ("Content") contained in this Proposal are owned or controlled by Freeman and are protected by United States and international copyright and trade secret laws. Modification or reproduction of the Content for any purpose is strictly prohibited.

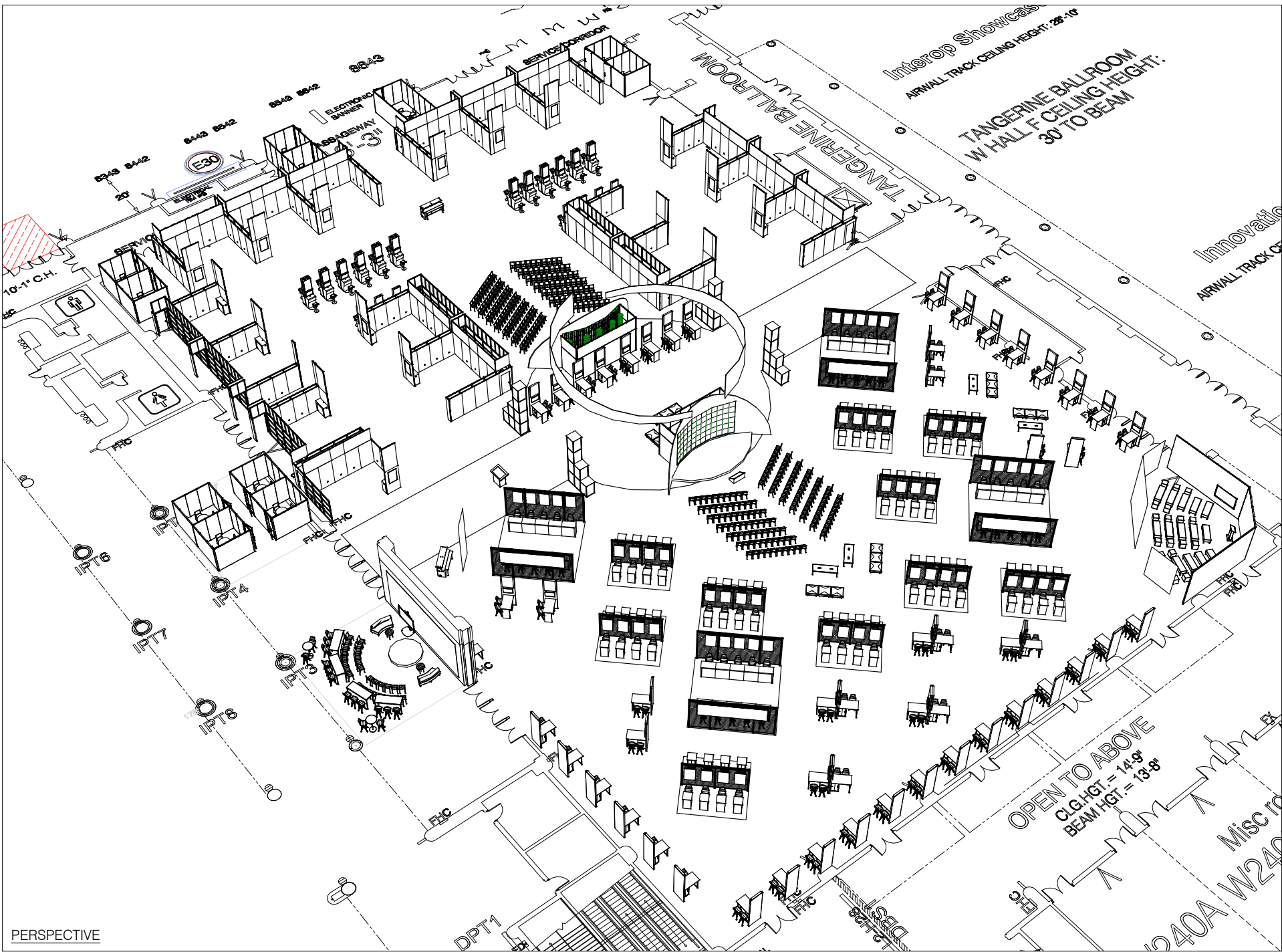

PERSPECTIVE

FREEMAN

PROJECT Innovation Live
BOOTH # 9001

SHOW NAME HIMSS 2019
SHOW DATE 2/12/2019 through 2/14/2019
SHOW LOCATION OCCC, FL

SALES CONTACT Moriah Hathway-Casey
JOB NUMBER 452520
LINE ITEM NUMBER 4689671

CREATED BY Orlando Romero

CREATION DATE 8/27/2018
REVISED 8/27/2018

PRODUCING BRANCH Orlando

FILE NAME P:/Chicago/Branch/NCRDC/_Out of Region/2019/HIMSS(452520)/Expo/Innovation Live/CAD/HIMSS19 Innovation Live 4689671 DES.dwg

The text, graphics, designs, logos, data compilations and information ("Content") contained in this Proposal are owned or controlled by Freeman and are protected by United States and international copyright and trade secret laws. Modification or reproduction of the Content for any purpose is strictly prohibited.

TAPERED CURVED BANNERS
(67'8" LINEAR FEET X 8' HEIGHT > 2' HEIGHT)

TAPERED CURVED BANNERS
(67'8" LINEAR FEET X 8' HEIGHT > 2' HEIGHT)

LED ILLUMINATED TOWERS
(16' / 8' / 4' HEIGHT)

PERSPECTIVE

F R E E M A N

PROJECT Innovation Live
BOOTH # 9001

SHOW NAME HIMSS 2019
SHOW DATE 2/12/2019 through 2/14/2019
SHOW LOCATION OCCC, FL

SALES CONTACT Moriah Hathway-Casey
JOB NUMBER 452520
LINE ITEM NUMBER 4689671

CREATED BY Orlando Romero

CREATION DATE 8/27/2018
REVISED 8/27/2018

PRODUCING BRANCH Orlando

FILE NAME P:/Chicago/Branch/NCRDC/_Out of Region/2019/HIMSS(452520)/Expo/Innovation Live/CAD/HIMSS19 Innovation Live 4689671 DES.dwg



CENTRAL HUB

F R E E M A N

PROJECT Innovation Live
BOOTH # 9001

SHOW NAME HIMSS 2019
SHOW DATE 2/12/2019 through 2/14/2019
SHOW LOCATION OCCC, FL

SALES CONTACT Moriah Hathway-Casey
JOB NUMBER 452520
LINE ITEM NUMBER 4689671

CREATED BY Orlando Romero

CREATION DATE 8/27/2018
REVISED 8/27/2018

PRODUCING BRANCH Orlando

FILE NAME P:/Chicago/Branch/NCRDC/_Out of Region/2019/HIMSS(452520)/Expo/Innovation Live/CAD/HIMSS19 Innovation Live 4689671 DES.dwg

The text, graphics, designs, logos, data compilations and information ("Content") contained in this Proposal are owned or controlled by Freeman and are protected by United States and international copyright and trade secret laws. Modification or reproduction of the Content for any purpose is strictly prohibited.

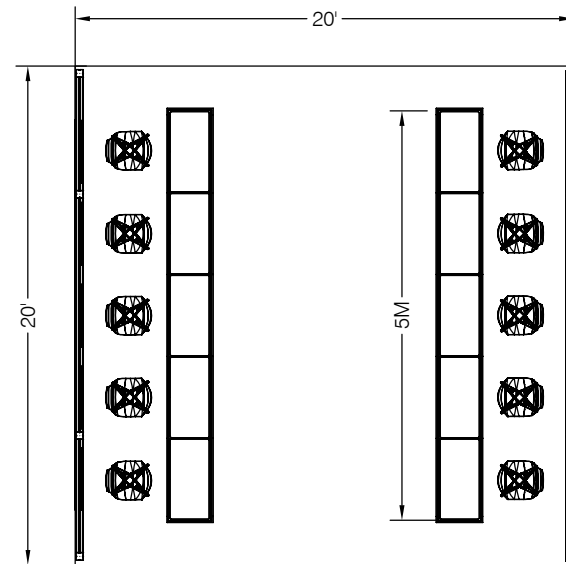
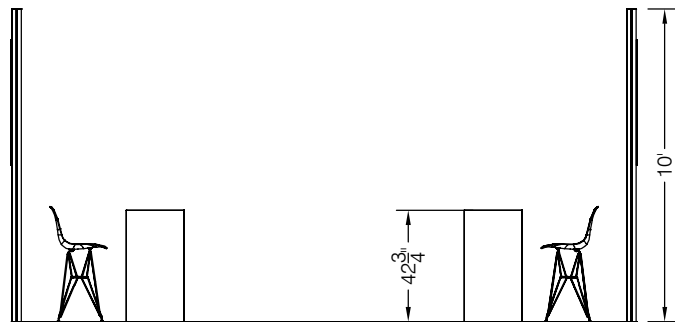
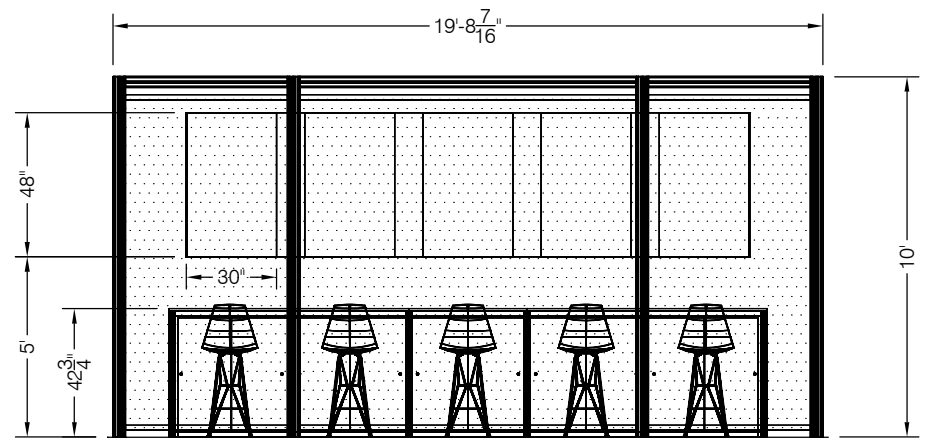
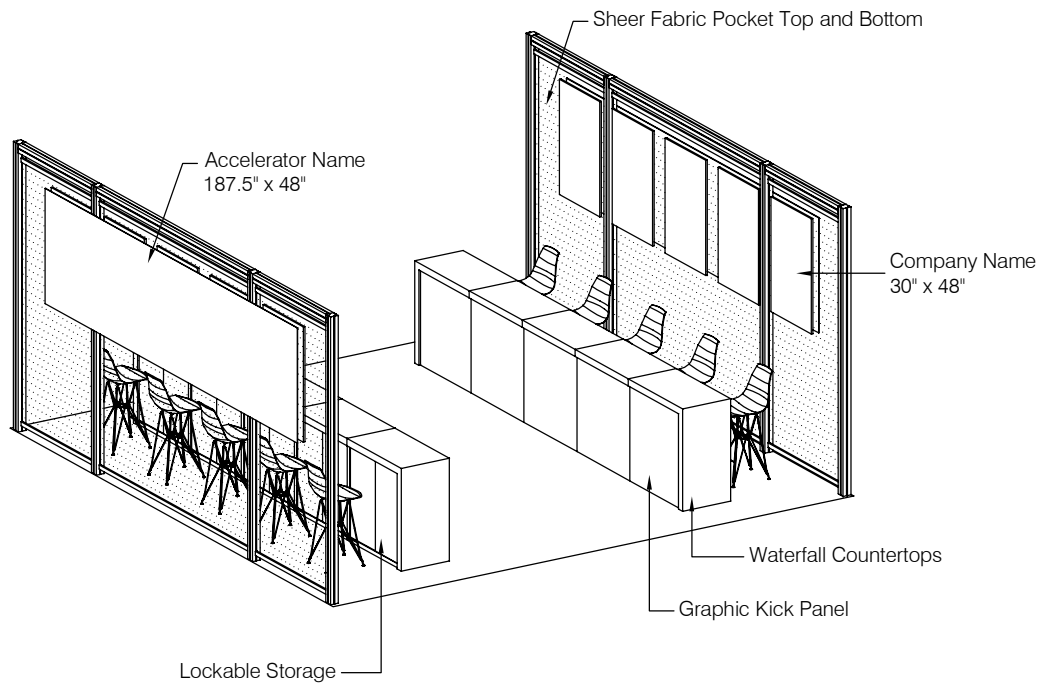

ACCELERATOR KIOSKS (10 COMPANIES PER 20X20 SPACE)



PROJECT Innovation Live
BOOTH # 9001

SHOW NAME HIMSS 2019
SHOW DATE 2/12/2019 through 2/14/2019
SHOW LOCATION OCCC, FL

SALES CONTACT Mariah Hathway-Casey
JOB NUMBER 452520
LINE ITEM NUMBER 4689671

CREATED BY Orlando Romero

CREATION DATE 6/25/2018
REVISED 6/25/2018

PRODUCING BRANCH Orlando

FILE NAME P:/Chicago/Branch/NCRDC/_Out of Region/2019/HIMSS(452520)/Expo/Innovation Live/CAD/HIMSS19 Innovation Live 4689671 DES.dwg

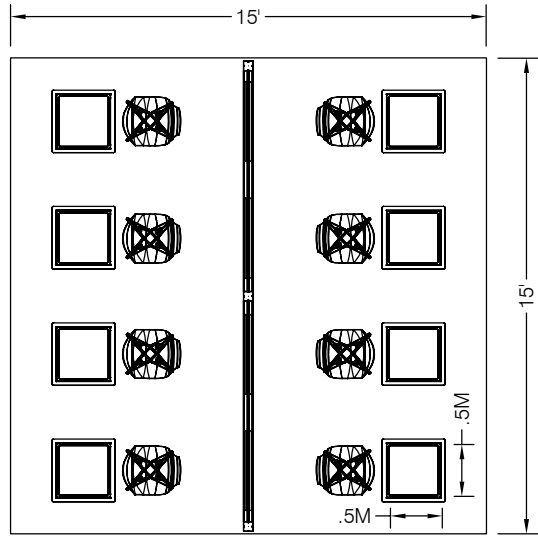
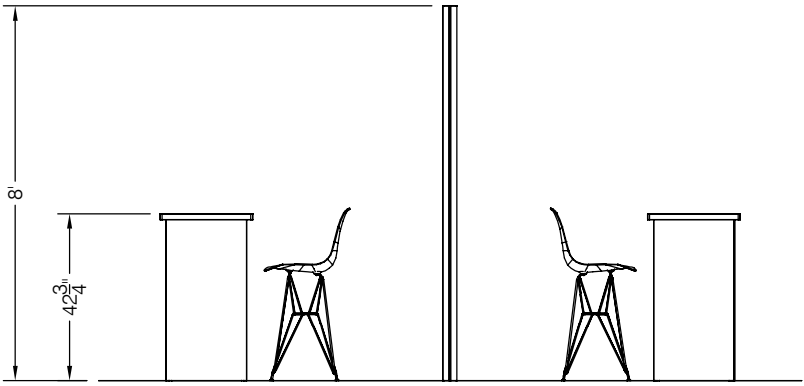
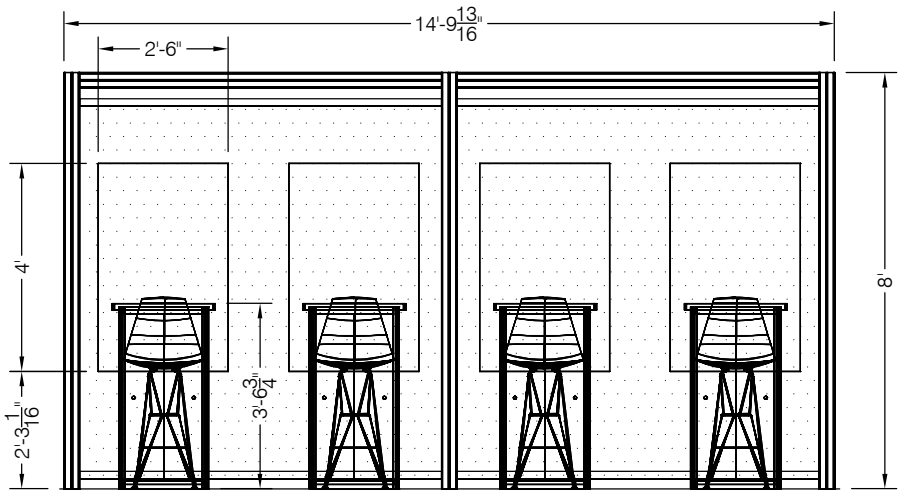
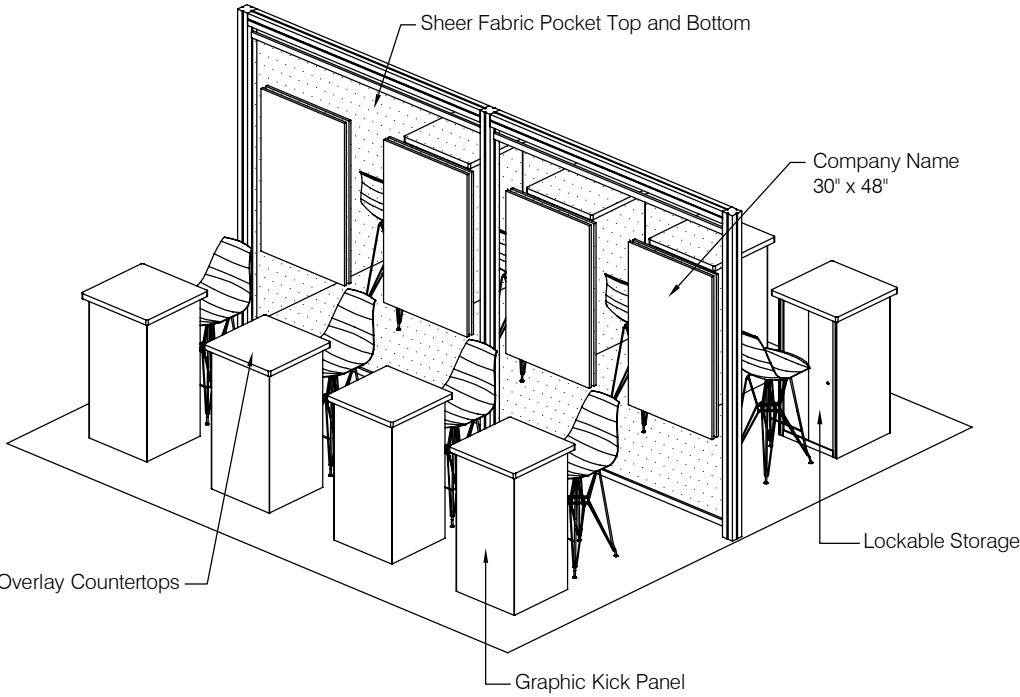

START UP KIOSK (8 COMPANIES PER 15X15 SPACE)

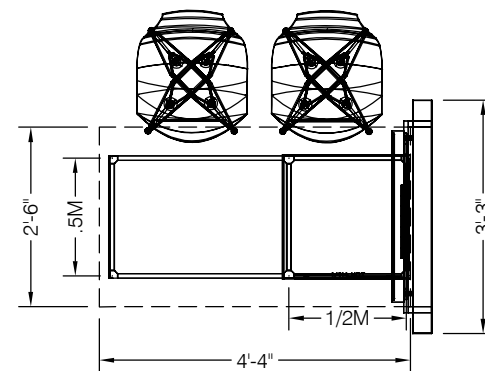
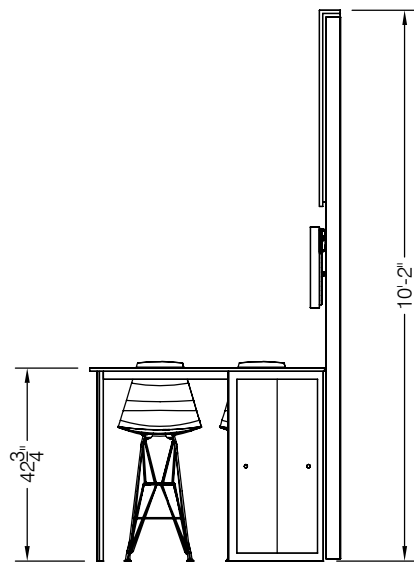
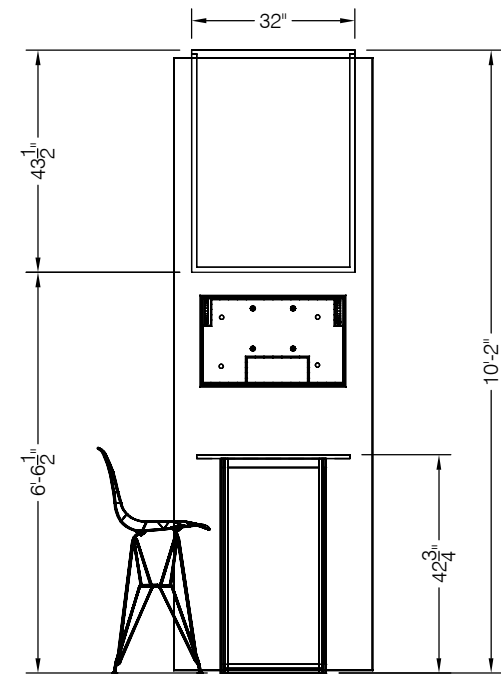
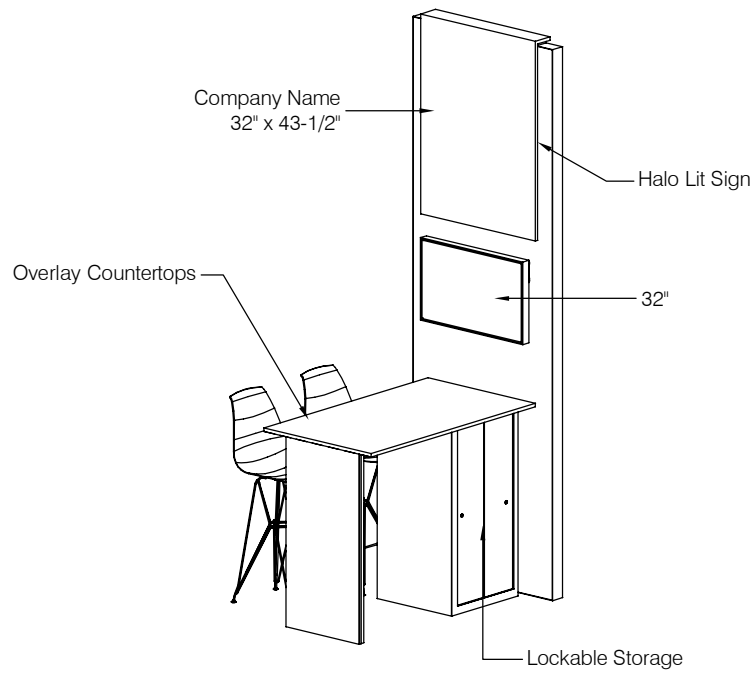

INNOVATION KIOSKS



PROJECT Innovation Live
BOOTH # 9001

SHOW NAME HIMSS 2019
SHOW DATE 2/12/2019 through 2/14/2019
SHOW LOCATION OCC, FL

SALES CONTACT Mariah Hathway-Casey
JOB NUMBER 452520
LINE ITEM NUMBER 4689671

CREATED BY Orlando Romero

CREATION DATE 6/25/2018

REVISED 6/25/2018

PRODUCING BRANCH Orlando

FILE NAME P:/Chicago/Branch/NCRDC/_Out of Region/2019/HIMSS(452520)/Expo/Innovation Live/CAD/HIMSS19 Innovation Live 4689671 DES.dwg

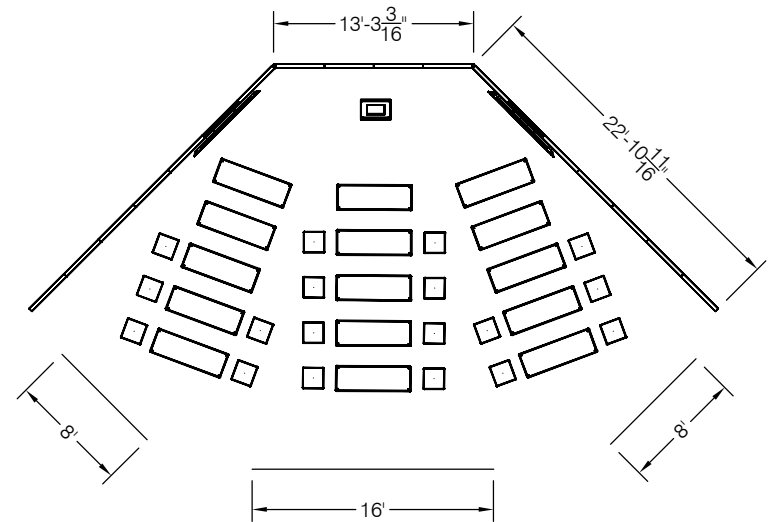
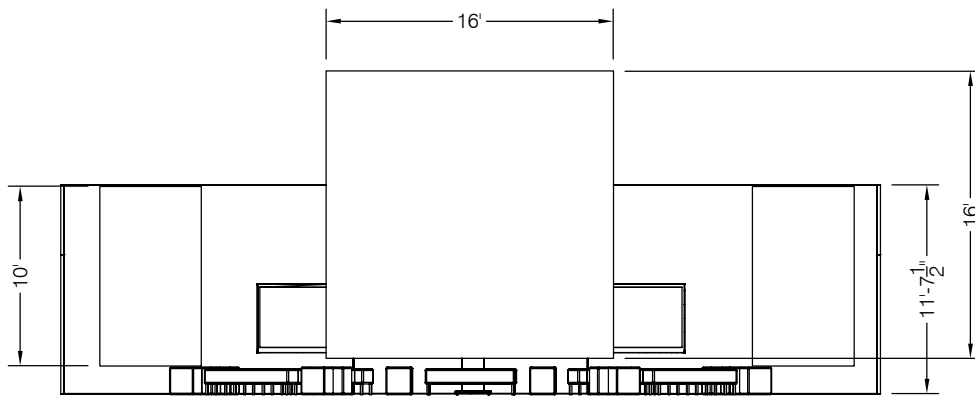
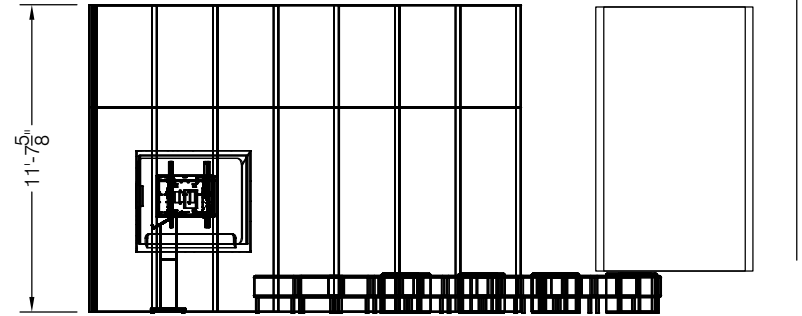
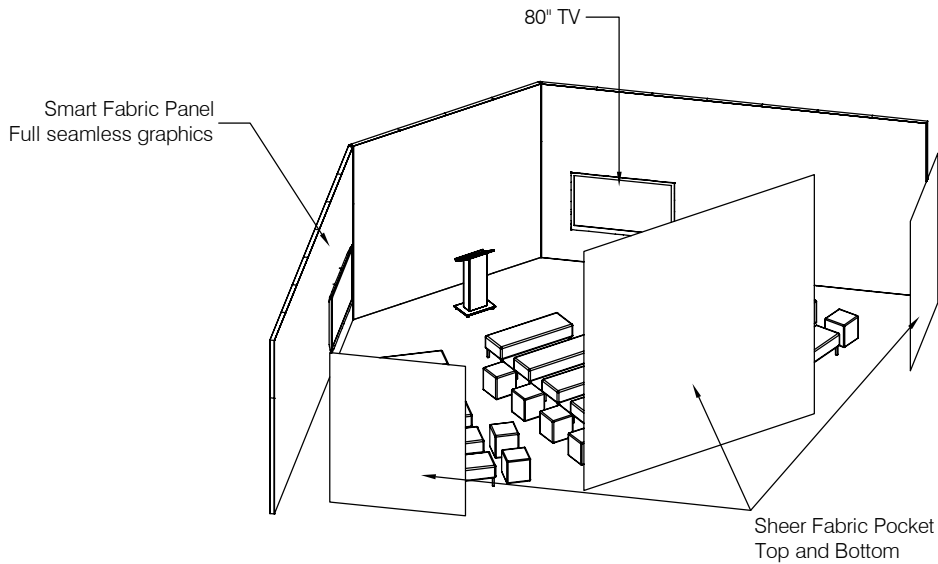

DEVELOPERS LAB

FREEMAN

PROJECT Innovation Live
BOOTH # 9001

SHOW NAME HIMSS 2019
SHOW DATE 2/12/2019 through 2/14/2019
SHOW LOCATION OCCC, FL

SALES CONTACT Mariah Hathway-Casey
JOB NUMBER 452520
LINE ITEM NUMBER 4689671

CREATED BY Orlando Romero

CREATION DATE 6/25/2018

REVISED 6/25/2018

PRODUCING BRANCH Orlando

FILE NAME P:/Chicago/Branch/NCRDC/_Out of Region/2019/HIMSS(452520)/Expo/Innovation Live/CAD/HIMSS19 Innovation Live 4689671 DES.dwg

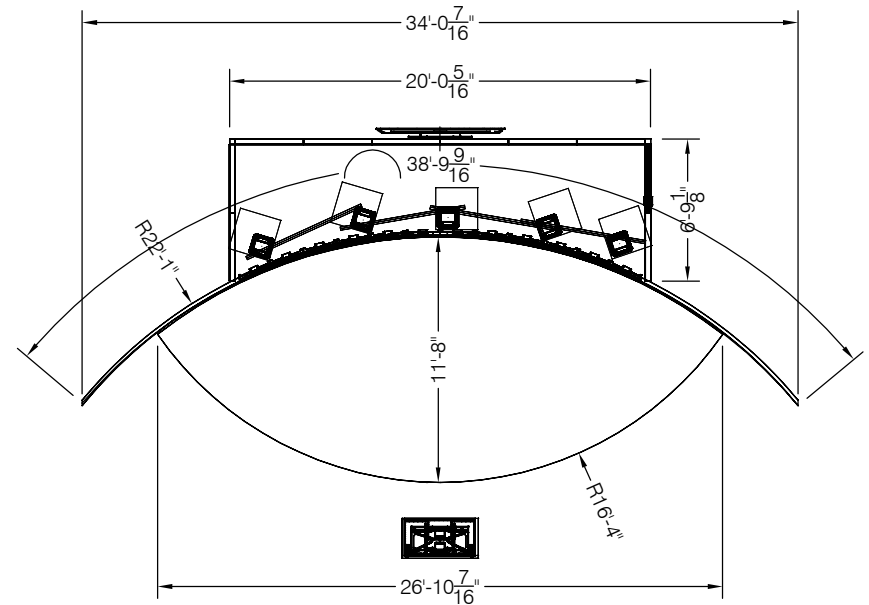
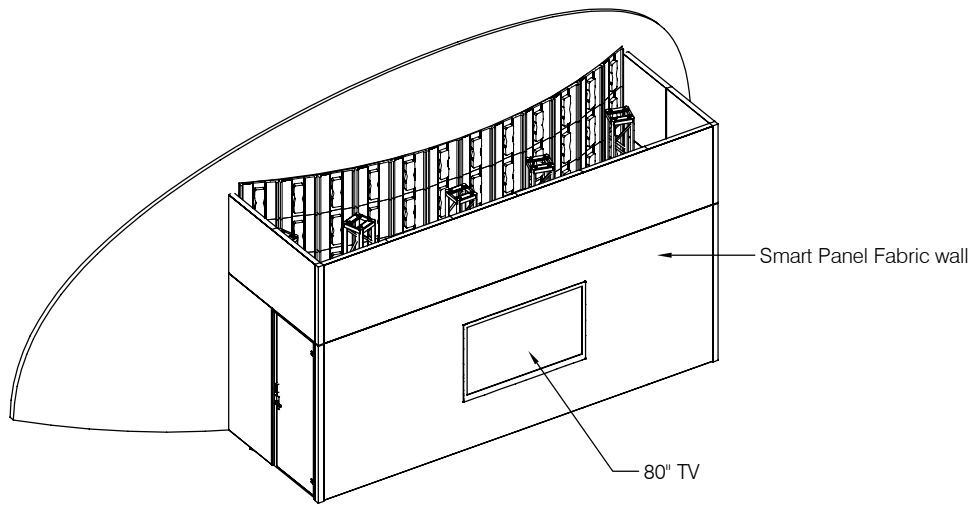
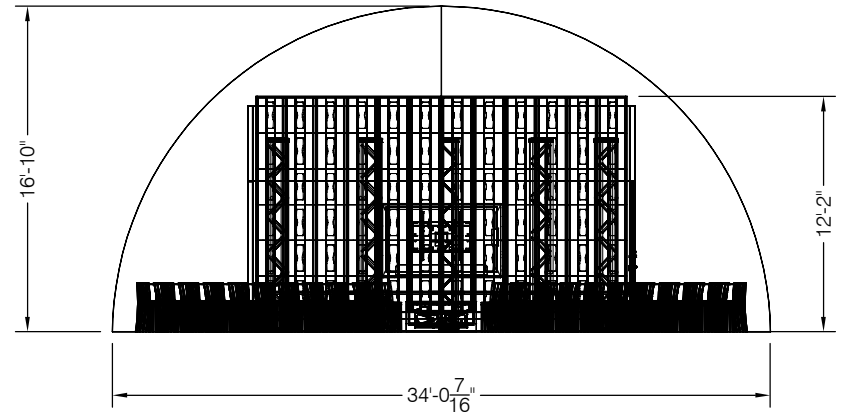
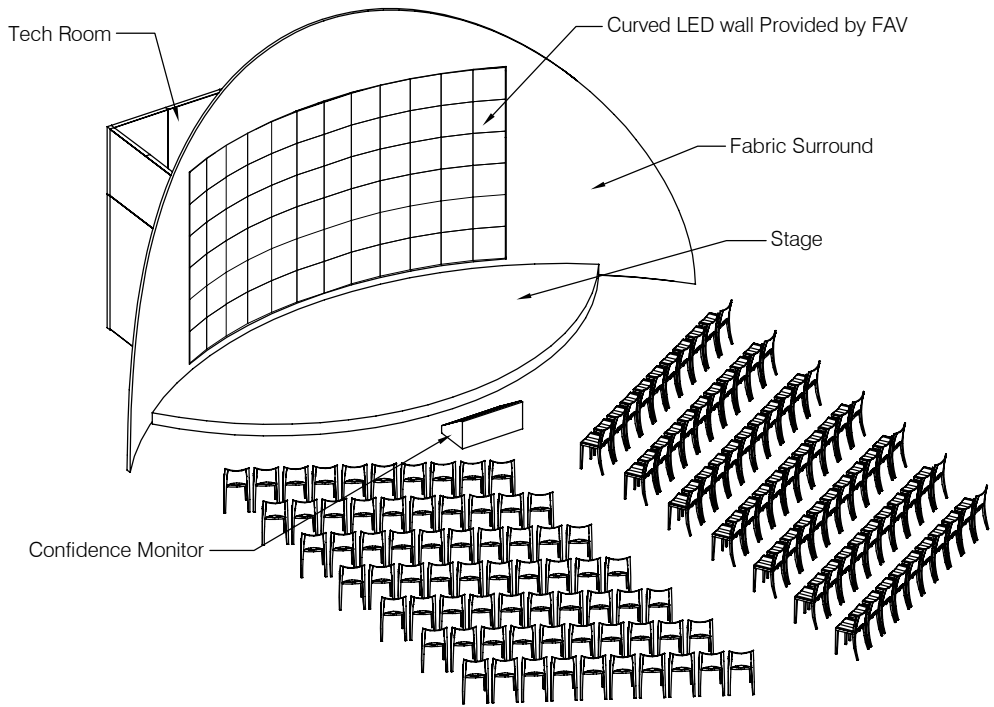

STAGE



PROJECT Innovation Live
BOOTH # 9001

SHOW NAME HIMSS 2019
SHOW DATE 2/12/2019 through 2/14/2019
SHOW LOCATION OCCC, FL

SALES CONTACT Mariah Hathway-Casey
JOB NUMBER 452520
LINE ITEM NUMBER 4689671

CREATED BY Orlando Romero

CREATION DATE 6/25/2018
REVISED 6/25/2018

PRODUCING BRANCH Orlando

FILE NAME P:/Chicago/Branch/NCRDC/_Out of Region/2019/HIMSS(452520)/Expo/Innovation Live/CAD/HIMSS19 Innovation Live 4689671 DES.dwg