

FHC

FHC

Lenovo (States),  
VHQ700

eClinicalWorks  
VHQ600

8'-4"

8'-4"

160'

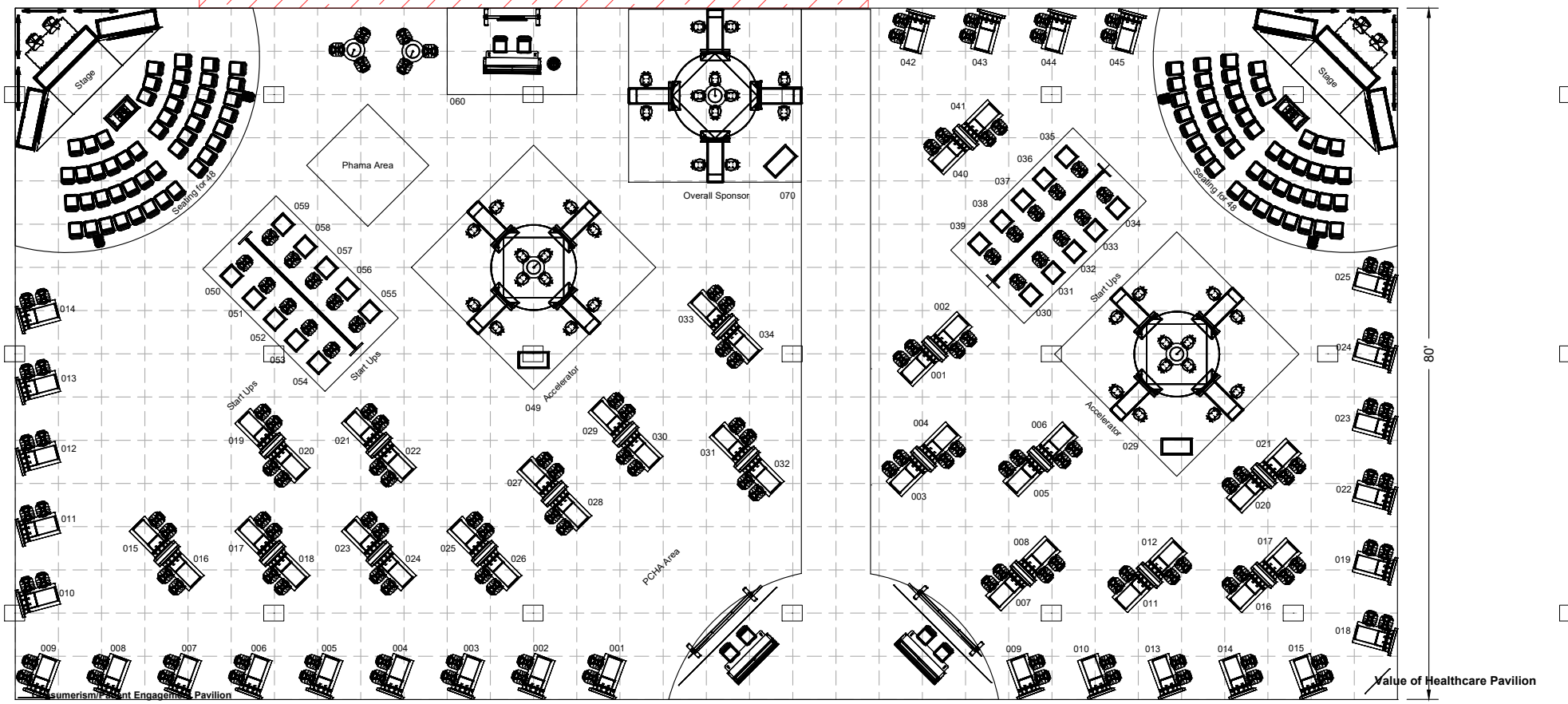

### Consumerism/Patient Engagement Pavilion

### Value of Healthcare Pavilion

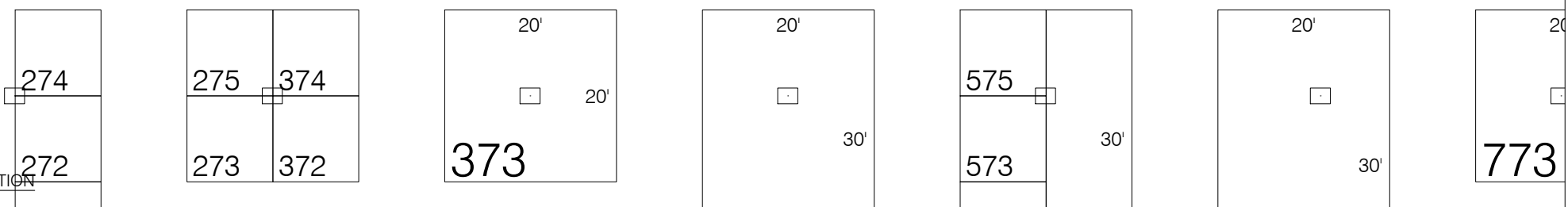

**FREEMAN**

PROJECT Consumerism/Patient Engagement Pavilion  
BOOTH # Mgmt

SHOW NAME HIMSS 2020  
SHOW DATE 3/9/2020 through 3/13/2020  
SHOW LOCATION Orange County Convention Center

SALES CONTACT EJ Shelly  
JOB NUMBER 454446  
LINE ITEM NUMBER 5510894

CREATED BY Orlando R. Kevin K.  
CREATION DATE 1/9/2020  
REVISED 1/9/2020  
PRODUCING BRANCH Orlando

FILE NAME P:\Chicago\Branch\NCRDC\ Out of Region\2020\HIMSS (454446)\Expo\Consumer Pavilion\CAD\Consumer HIMSS20 5510894 DES.dwg

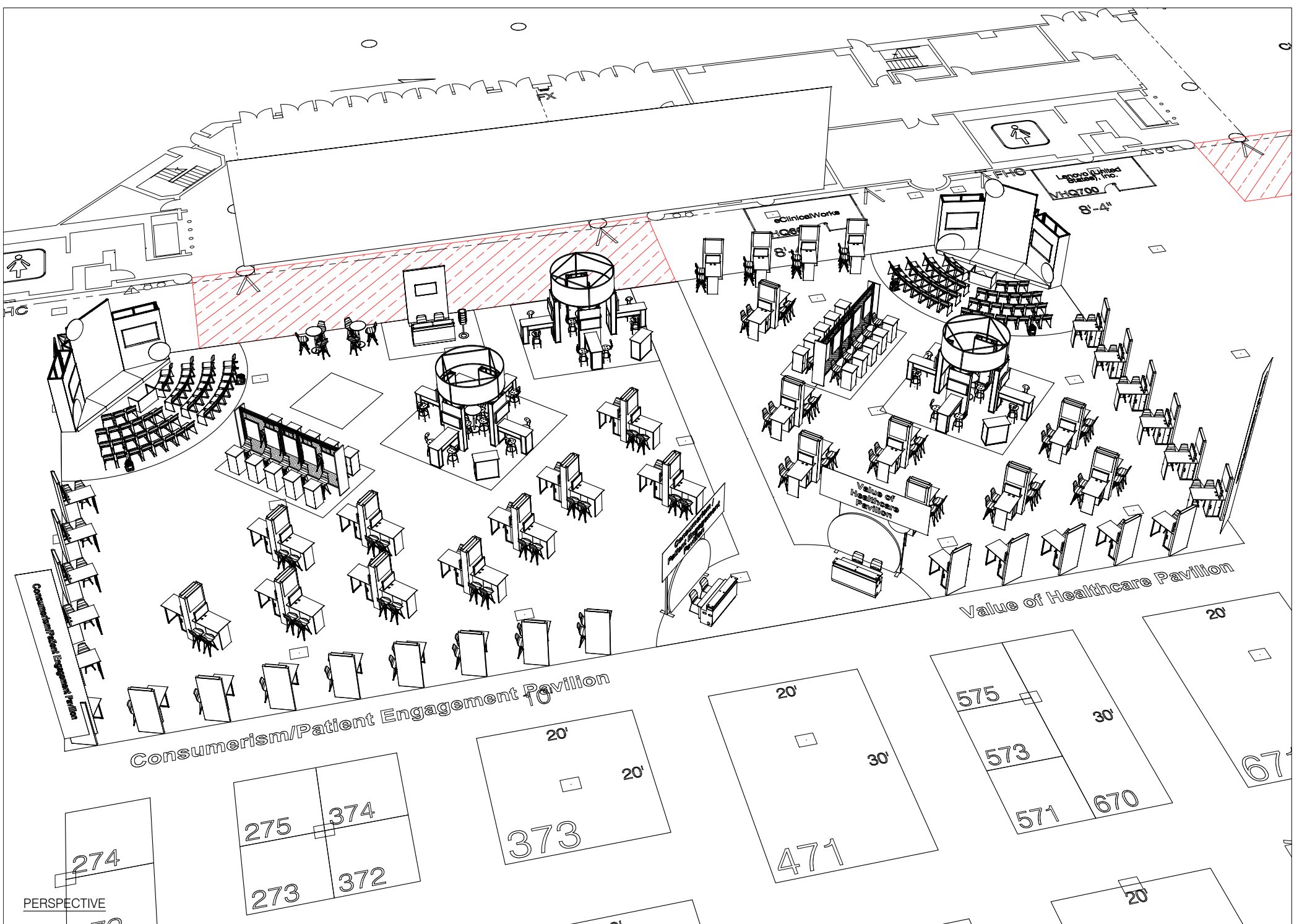

PERSPECTIVE

**F R E E M A N**

PROJECT Consumerism/Patient Engagement Pavilion  
BOOTH # Mgmt

SHOW NAME HIMSS 2020  
SHOW DATE 3/9/2020 through 3/13/2020  
SHOW LOCATION Orange County Convention Center

SALES CONTACT EJ Shelly  
JOB NUMBER 454446  
LINE ITEM NUMBER 5510894

CREATED BY Orlando R. Kevin K.

CREATION DATE 1/9/2020  
REVISED 1/9/2020  
PRODUCING BRANCH Orlando

FILE NAME P:\Chicago\Branch\NCRDC\ Out of Region\2020\HIMSS (454446)\Expo\Consumer Pavilion\CAD\Consumer HIMSS20 5510894 DES.dwg

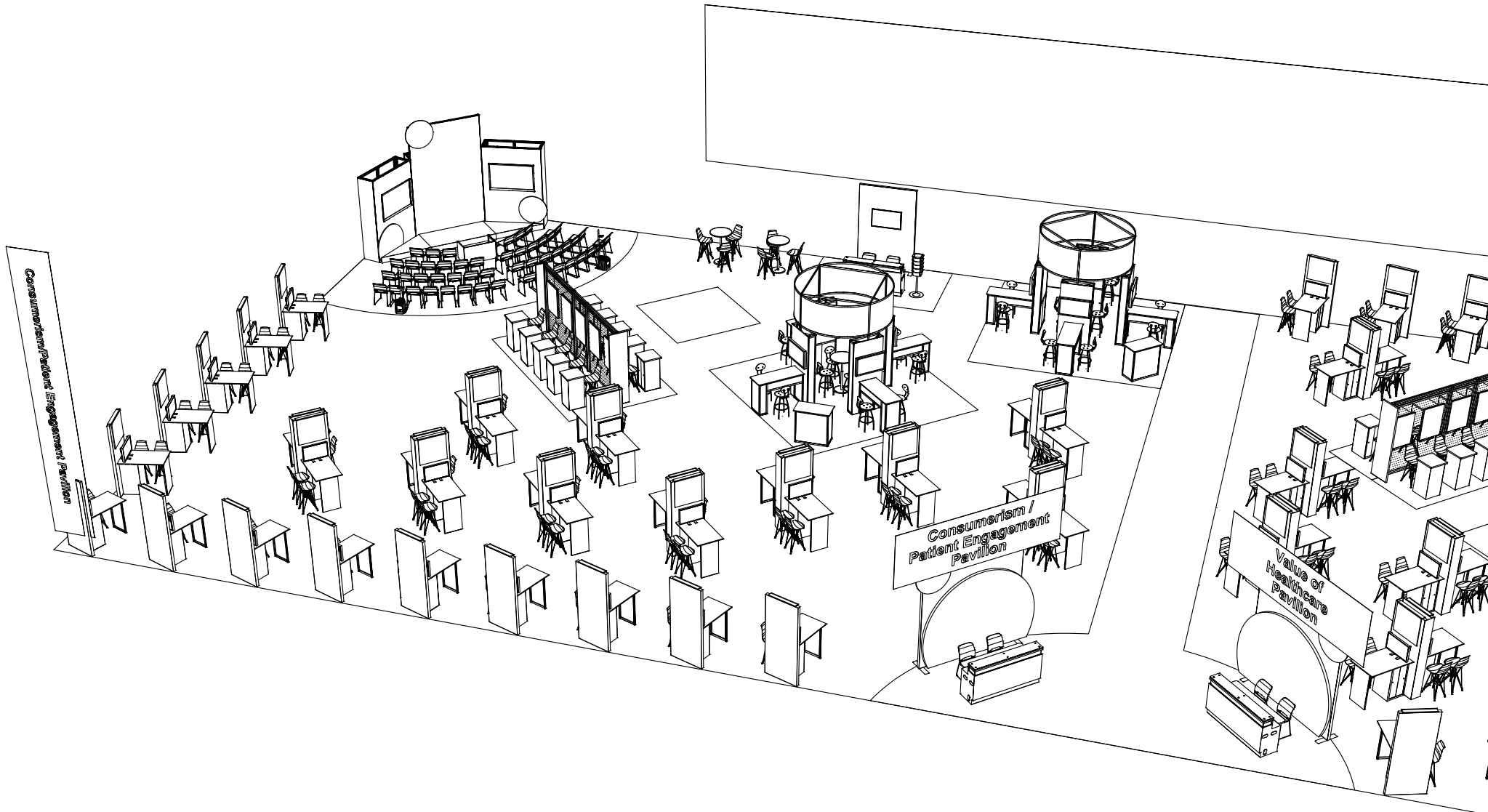

PERSPECTIVE

**F R E E M A N**

PROJECT Consumerism/Patient Engagement Pavilion  
 BOOTH # Mgmt

SHOW NAME HIMSS 2020  
 SHOW DATE 3/9/2020 through 3/13/2020  
 SHOW LOCATION Orange County Convention Center

SALES CONTACT EJ Shelly  
 JOB NUMBER 454446  
 LINE ITEM NUMBER 5510894

CREATED BY Orlando R. Kevin K.

CREATION DATE 1/9/2020

REVISED 1/9/2020

PRODUCING BRANCH Orlando

FILE NAME P:/Chicago/Branch/NCRDC/\_Out of Region/2020/HIMSS (454446)/Expo/Consumer Pavilion/CAD/Consumer HIMSS20 5510894 DES.dwg

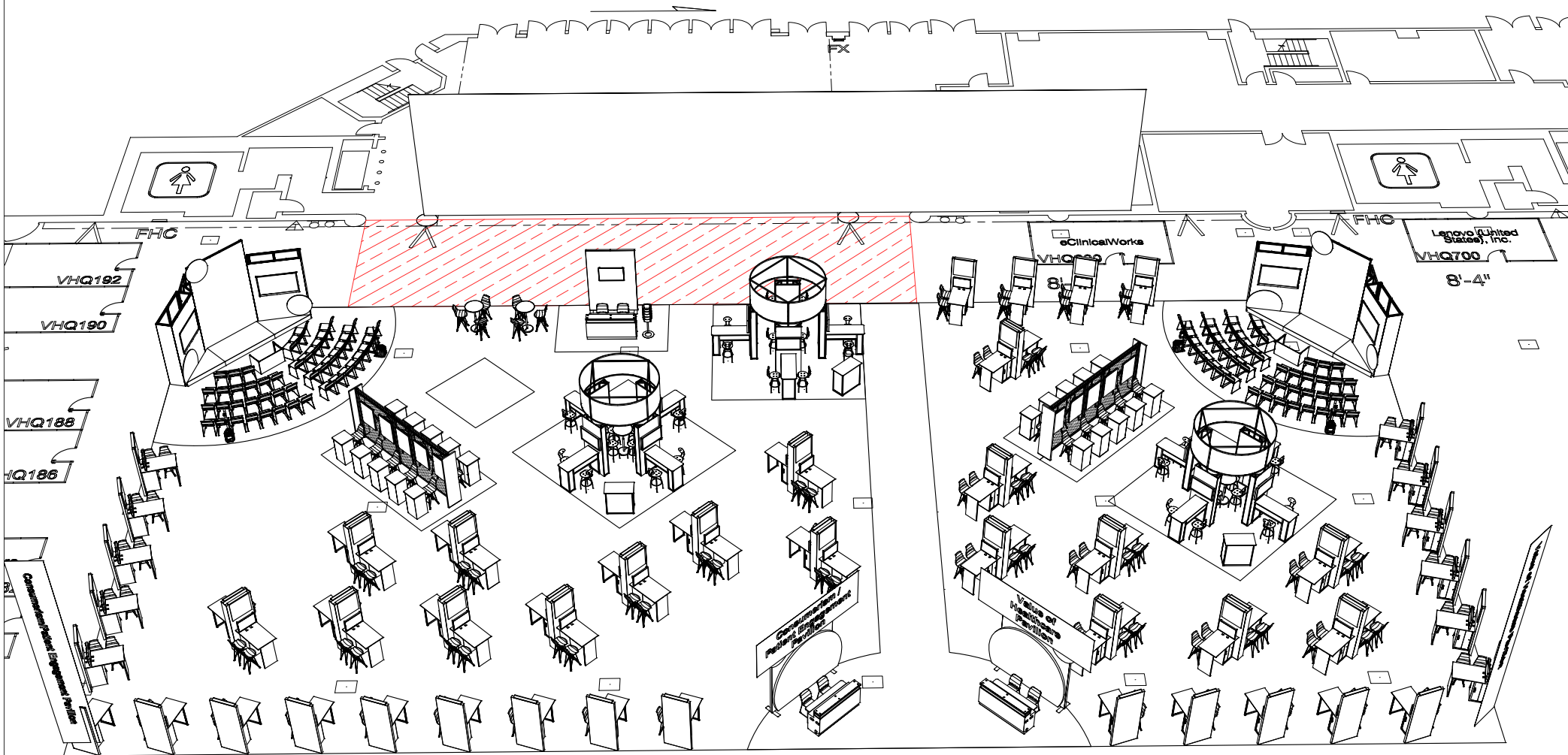

Consumerism/Patient Engagement Pavilion

Value of Healthcare Pavilion

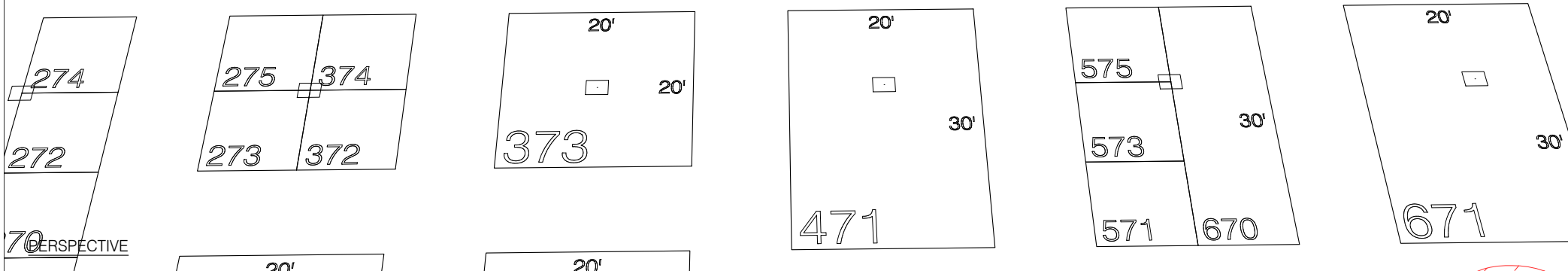

70 PERSPECTIVE

**F R E E M A N**

PROJECT Consumerism/Patient Engagement Pavilion  
BOOTH # Mgmt

SHOW NAME HIMSS 2020  
SHOW DATE 3/9/2020 through 3/13/2020  
SHOW LOCATION Orange County Convention Center

SALES CONTACT EJ Shelly  
JOB NUMBER 454446  
LINE ITEM NUMBER 5510894

CREATED BY Orlando R. Kevin K.

CREATION DATE 1/9/2020

REVISED 1/9/2020

PRODUCING BRANCH Orlando

FILE NAME P:\Chicago\Branch\NCRDC\ Out of Region\2020\HIMSS (454446)\Expo\Consumer Pavilion\CAD\Consumer HIMSS20 5510894 DES.dwg

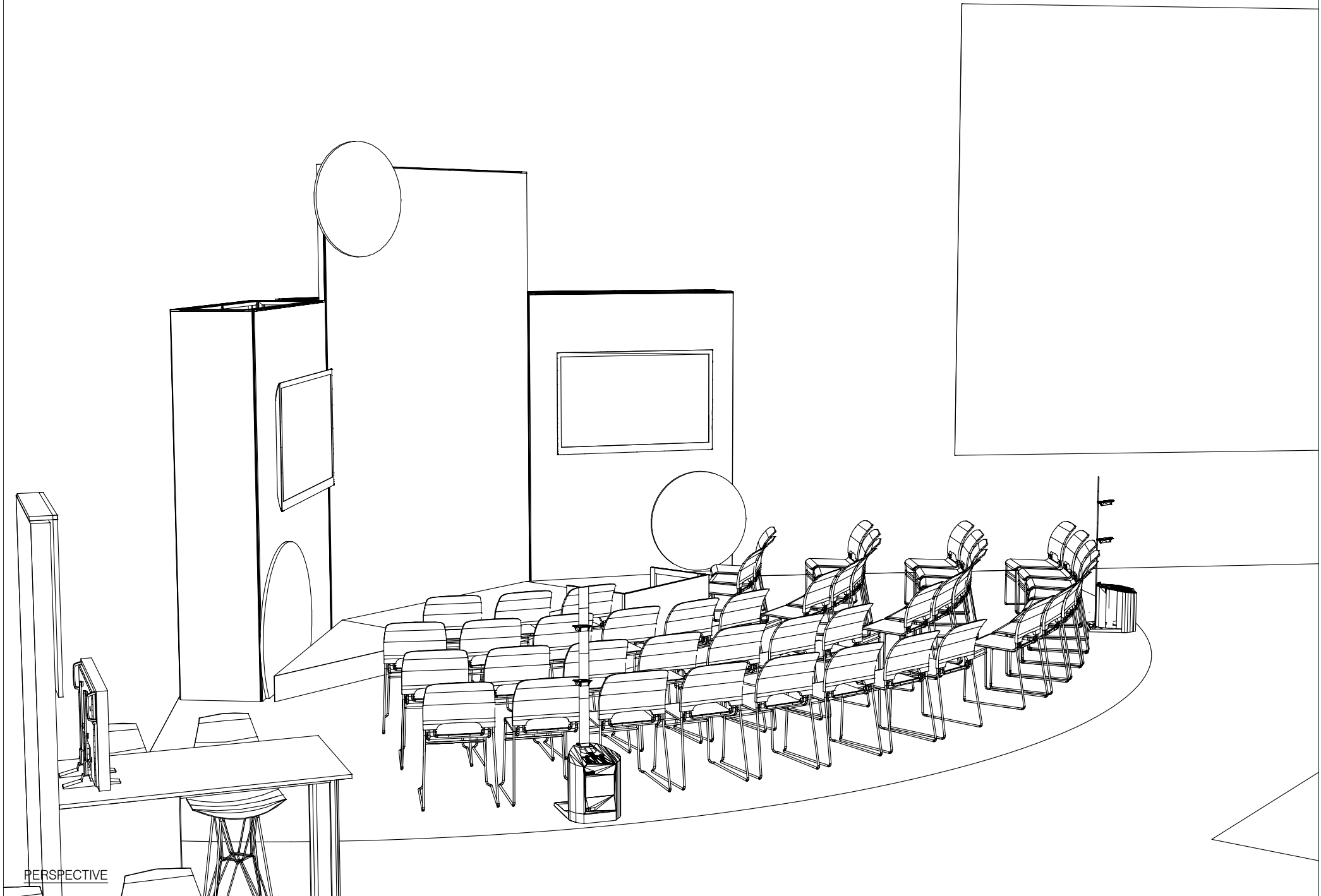

PERSPECTIVE

**F R E E M A N**

PROJECT Consumerism/Patient Engagement Pavilion  
BOOTH # Mgmt

SHOW NAME HIMSS 2020  
SHOW DATE 3/9/2020 through 3/13/2020  
SHOW LOCATION Orange County Convention Center

SALES CONTACT EJ Shelly  
JOB NUMBER 454446  
LINE ITEM NUMBER 5510894

CREATED BY Orlando R. Kevin K.

CREATION DATE 1/9/2020

REVISED 1/9/2020

PRODUCING BRANCH Orlando

FILE NAME P:/Chicago/Branch/NCRDC/\_Out of Region/2020/HIMSS (454446)/Expo/Consumer Pavilion/CAD/Consumer HIMSS20 5510894 DES.dwg

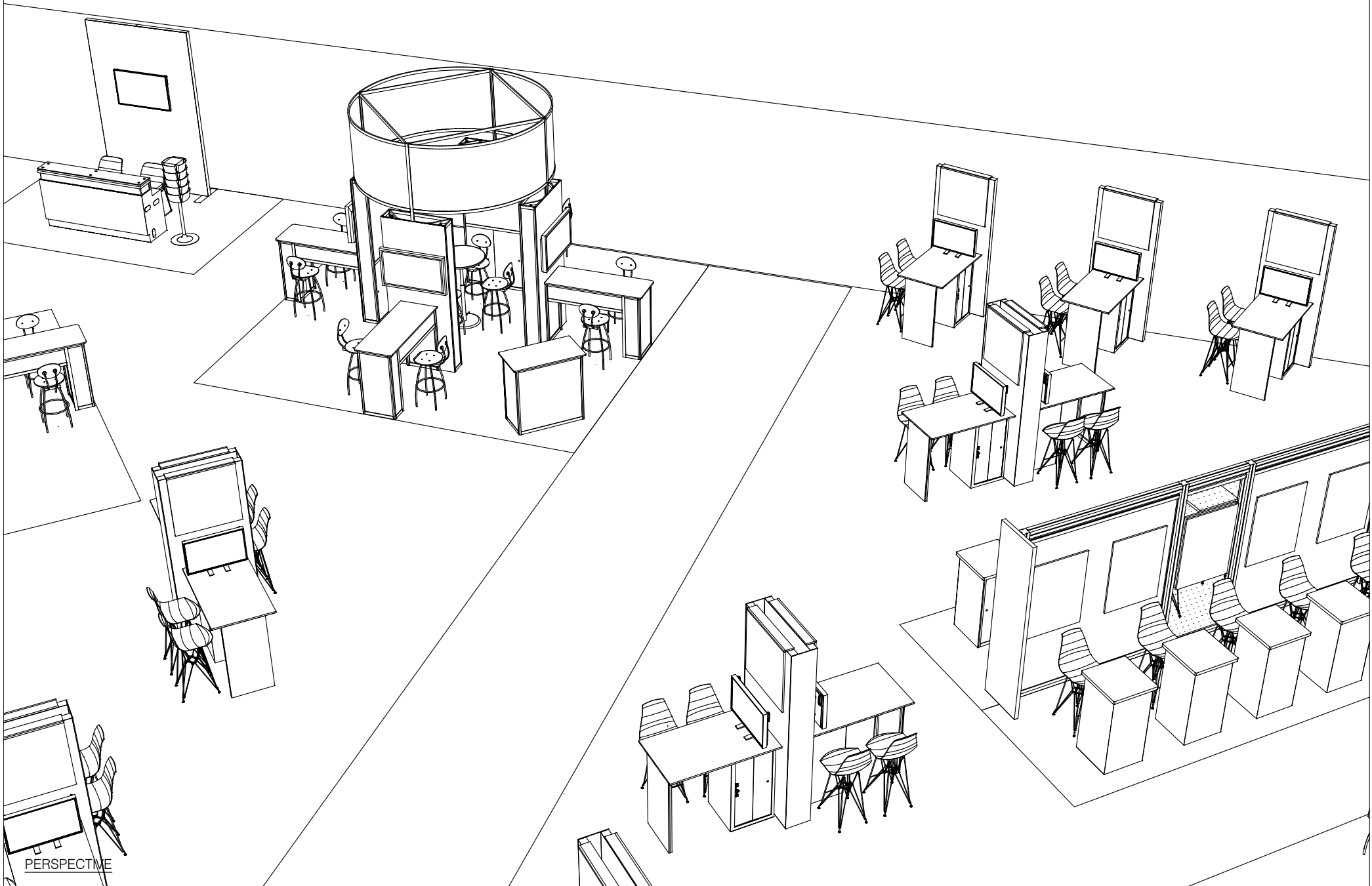

PERSPECTIVE

**F R E E M A N**

PROJECT Consumerism/Patient Engagement Pavilion  
BOOTH # Mgmt

SHOW NAME HIMSS 2020  
SHOW DATE 3/9/2020 through 3/13/2020  
SHOW LOCATION Orange County Convention Center

SALES CONTACT EJ Shelly  
JOB NUMBER 454446  
LINE ITEM NUMBER 5510894

CREATED BY Orlando R. Kevin K.

CREATION DATE 1/9/2020  
REVISED 1/9/2020  
PRODUCING BRANCH Orlando

FILE NAME P:/Chicago/Branch/NCRDC/\_Out of Region/2020/HIMSS (454446)/Expo/Consumer Pavilion/CAD/Consumer HIMSS20 5510894 DES.dwg

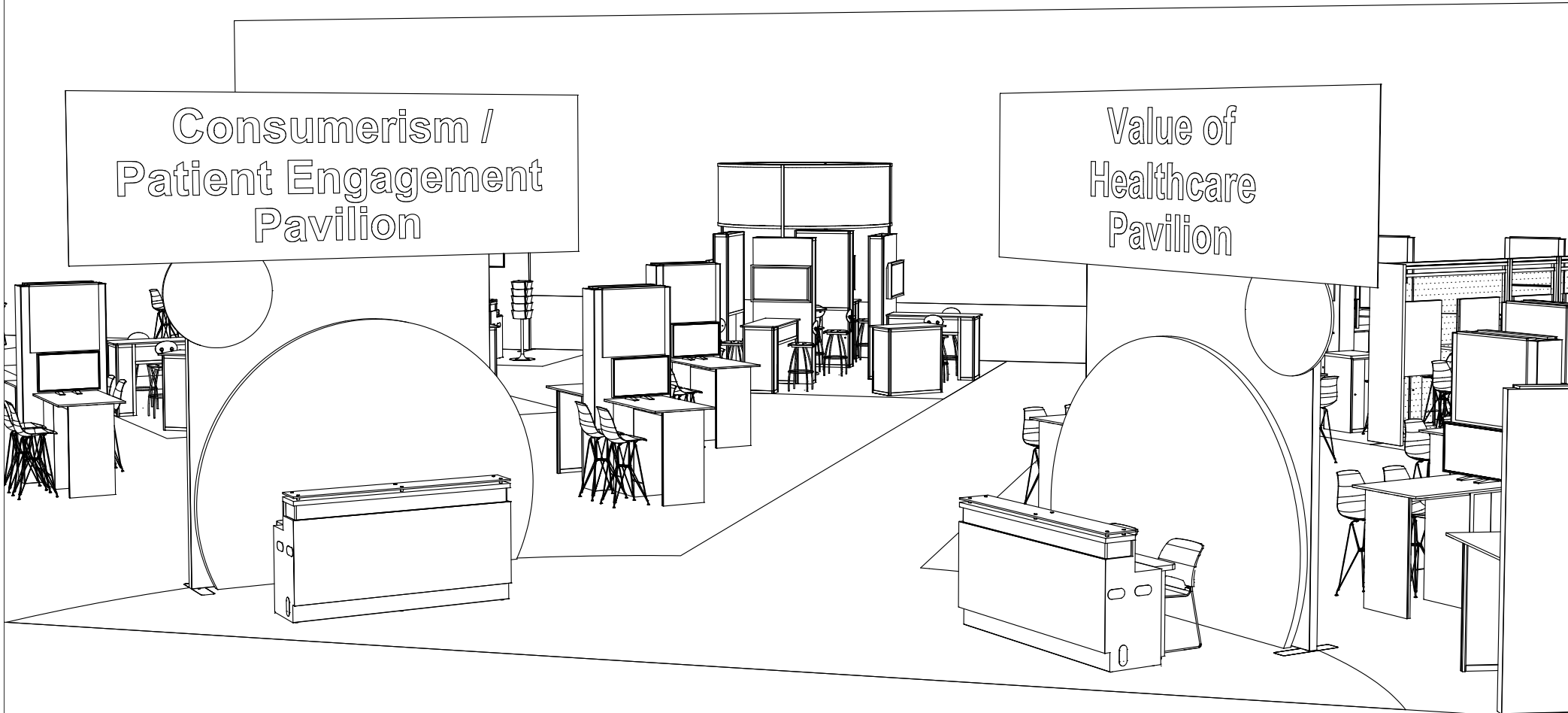

PERSPECTIVE

**F R E E M A N**

PROJECT Consumerism/Patient Engagement Pavilion  
BOOTH # Mgmt

SHOW NAME HIMSS 2020  
SHOW DATE 3/9/2020 through 3/13/2020  
SHOW LOCATION Orange County Convention Center

SALES CONTACT EJ Shelly  
JOB NUMBER 454446  
LINE ITEM NUMBER 5510894

CREATED BY Orlando R. Kevin K.

CREATION DATE 1/9/2020  
REVISED 1/9/2020  
PRODUCING BRANCH Orlando

FILE NAME P:/Chicago/Branch/NCRDC/\_Out of Region/2020/HIMSS (454446)/Expo/Consumer Pavilion/CAD/Consumer HIMSS20 5510894 DES.dwg

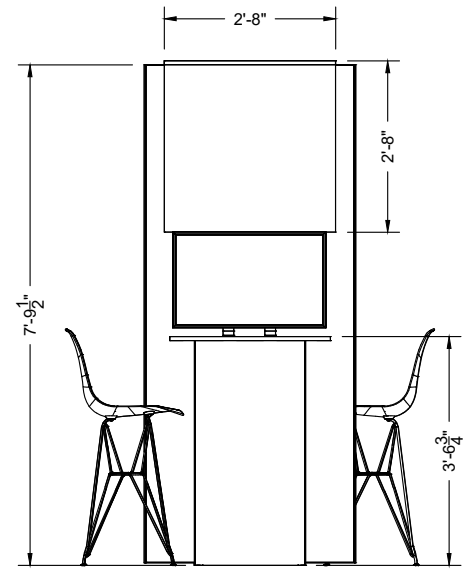
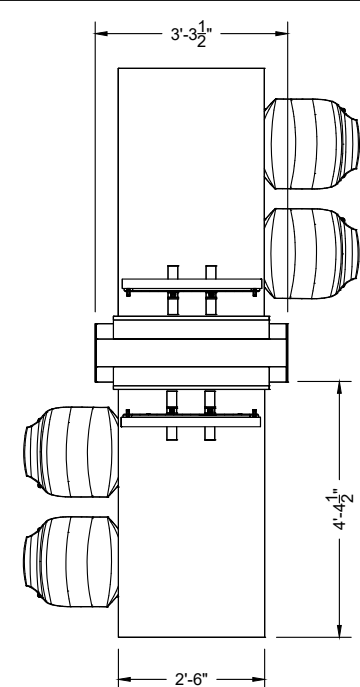
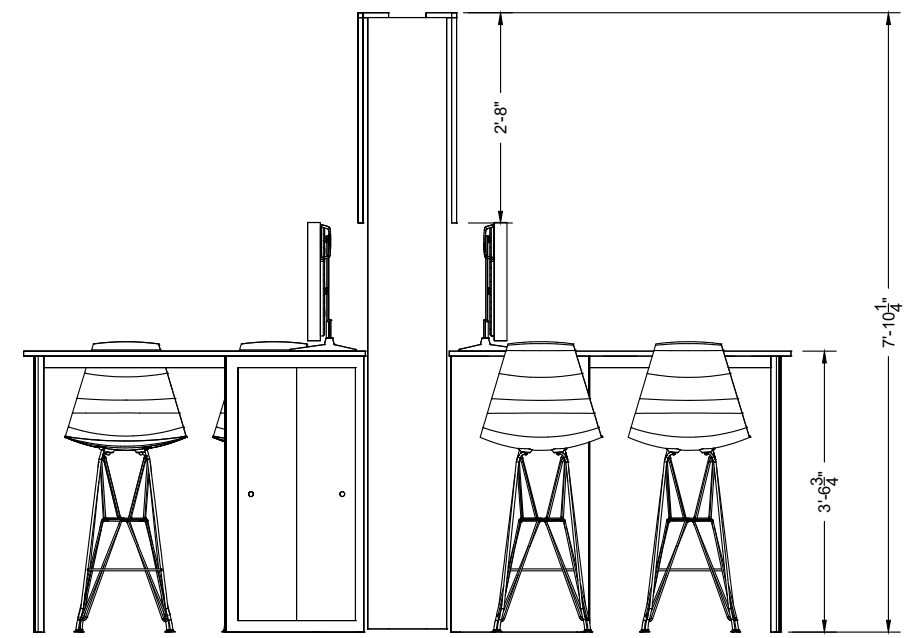
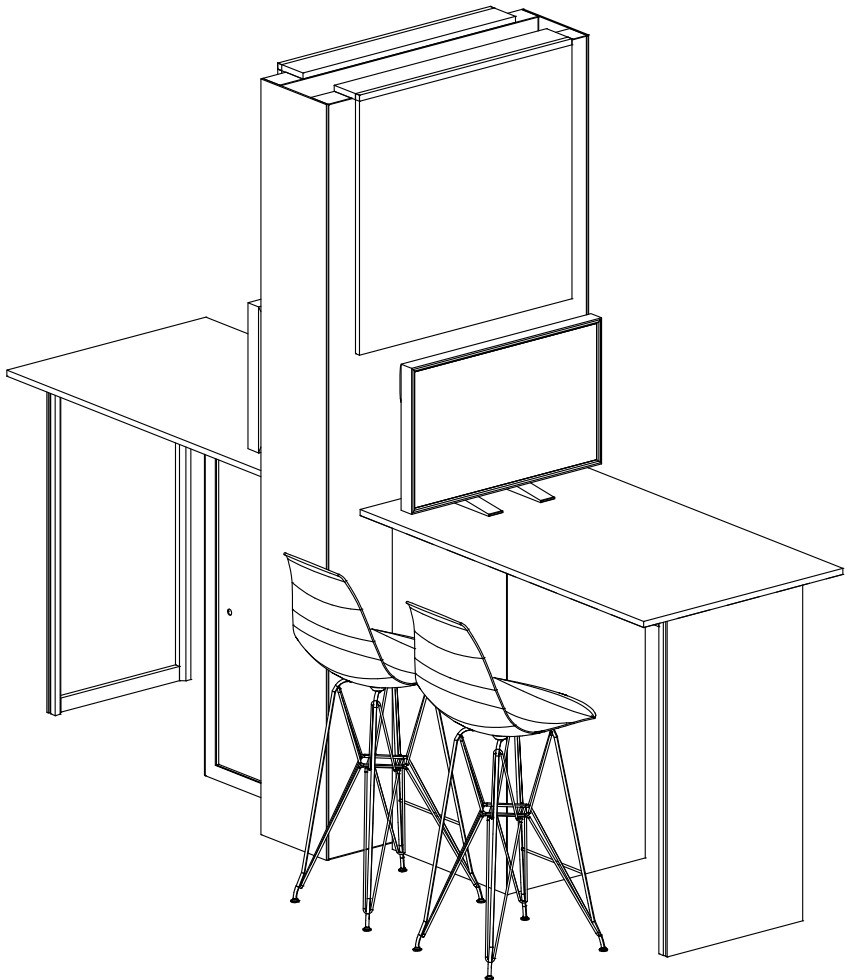

PERSPECTIVE



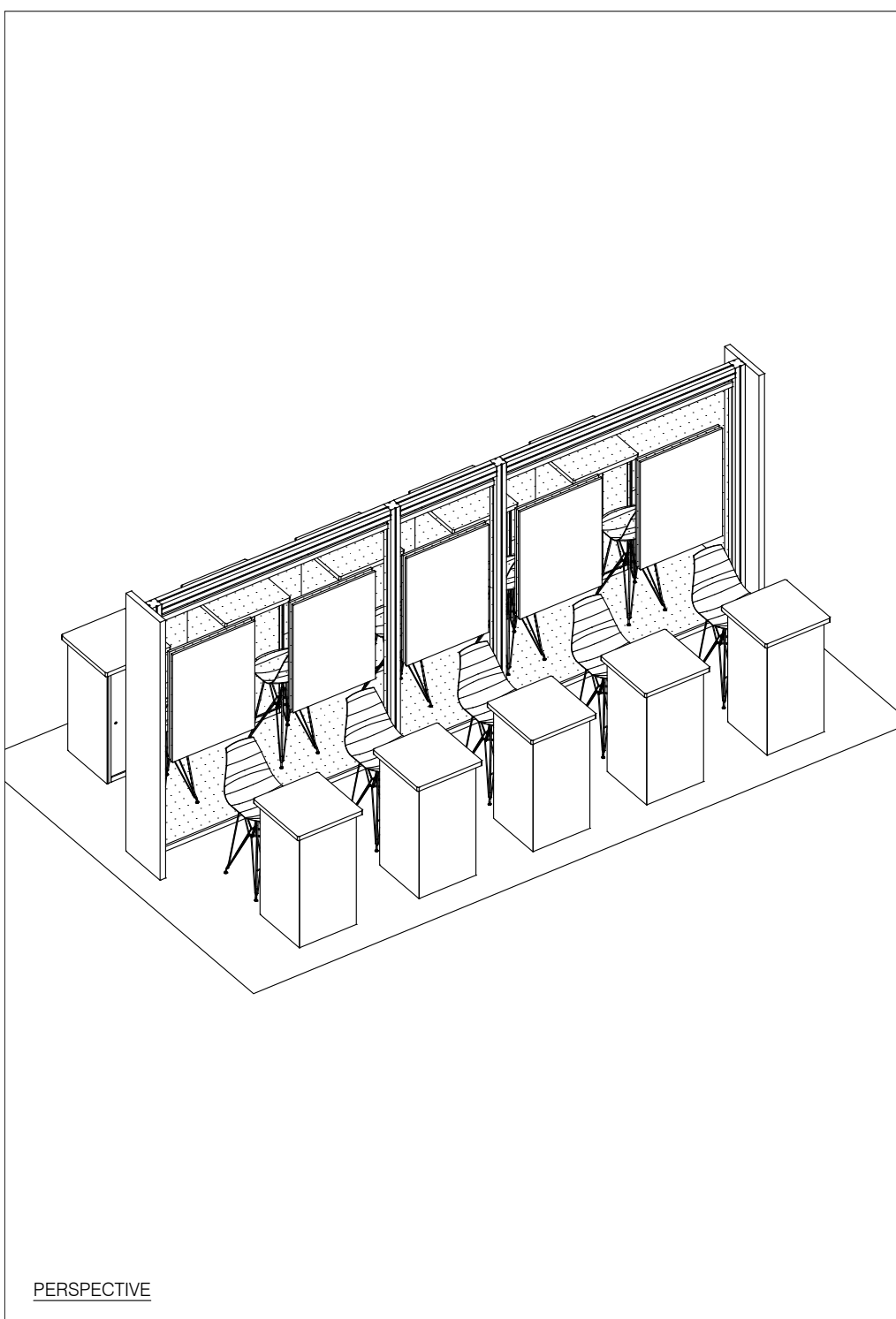

PERSPECTIVE

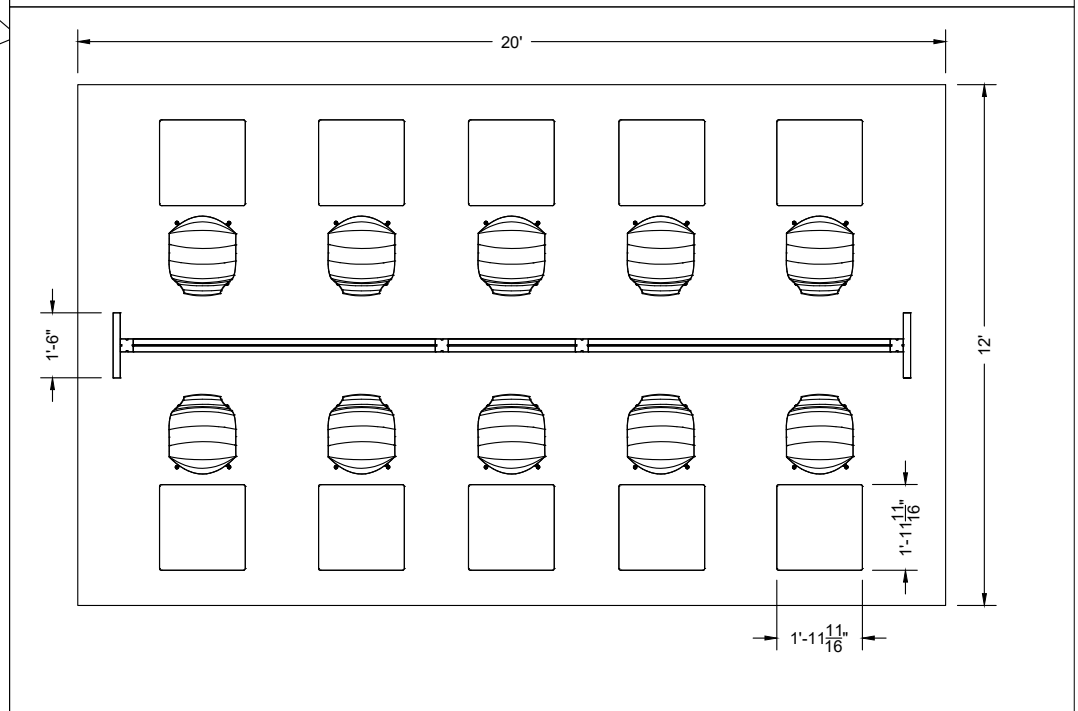
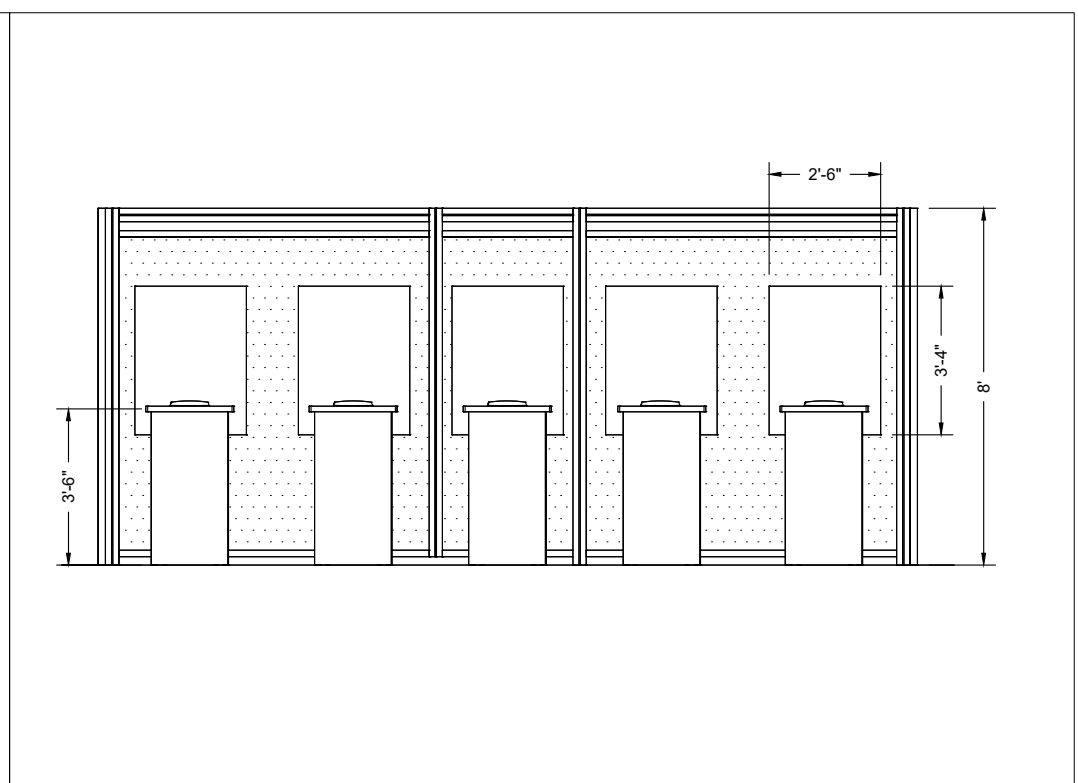

**F R E E M A N**

PROJECT Consumerism/Patient Engagement Pavilion  
BOOTH # Mgmt

SHOW NAME HIMSS 2020  
SHOW DATE 3/9/2020 through 3/13/2020  
SHOW LOCATION Orange County Convention Center

SALES CONTACT EJ Shelly  
JOB NUMBER 454446  
LINE ITEM NUMBER 5510894

CREATED BY Orlando R. Kevin K.

CREATION DATE 1/9/2020  
REVISED 1/9/2020  
PRODUCING BRANCH Orlando

FILE NAME P:/Chicago/Branch/NCRDC/\_Out of Region/2020/HIMSS (454446)/Expo/Consumer Pavilion/CAD/Consumer HIMSS20 5510894 DES.dwg